

---

*Comfort-Aire*®

**Century**®

---

## **Installation Manual**

# **Horizontal/Side Discharge Condensing Units**

### **Model**

CMA1512SA-1

CMA1518SA-1

CMA1524SA-1

CMA1530SA-1

CMA1536SA-1

CMA1548SA-1

#### **IMPORTANT NOTE:**

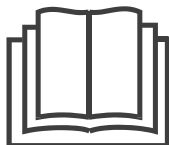

Read this manual carefully before installing or operating your new air conditioning unit. Make sure to save this manual for future reference.



# INSTALLATION MANUAL

SAFETY PRECAUTIONS .....	02
ACCESSORIES .....	06
REFRIGERANT PIPING CONNECTION .....	07
OUTDOOR UNIT INSTALLATION .....	11
WIRING .....	15
SPECIFICATIONS .....	20
AIR EVACUATION .....	21
NOTE ON ADDING REFRIGERANT .....	22
TEST RUN .....	23

## Read this manual

Inside you'll find many helpful hints on how to use and maintain your air conditioner properly. Just a little preventive care on your part can save you a great deal of time and money over the life of your air conditioner. These instructions may not cover every possible condition of use, so common sense and attention to safety is required when installing, operating and maintaining this product.

# SAFETY PRECAUTIONS

## Intended Use

The following safety guidelines are intended to prevent unforeseen risks or damage from unsafe or incorrect operation of the appliance. Please check the packaging and appliance on arrival to make sure everything is intact to ensure safe operation. If you find any damage, please contact the retailer or dealer. Please note modifications or alterations to the appliance are not allowed for your safety. Unintended use may cause hazards and loss of warranty claims.

## Explanation of Symbols



### WARNING

The signal word indicates a hazard with a medium level of risk which, if not avoided, may result in death or serious injury.



### CAUTION

The signal word indicates a hazard with a low degree of risk which, if not avoided, may result in minor or moderate injury.



### NOTICE

The signal word indicates important information (e.g., damage to property), but not danger.

Read these operating instructions carefully and attentively before using/commissioning the unit and keep them in the immediate vicinity of the installation site or unit for later use!

## WARNING

This appliance is not intended for use by persons (including children) with reduced physical, sensory or mental capabilities, or lack of experience and knowledge, unless they have been given supervision or instruction concerning use of the appliance by a person responsible for their safety. Children should be supervised to ensure that they do not play with the appliance.

## WARNINGS FOR PRODUCT USE

- If an abnormal situation arises (like a burning smell), immediately turn off the unit and disconnect the power. Call your dealer for instructions to avoid electric shock, fire or injury.
- **Do not** insert fingers, rods or other objects into the air inlet or outlet. This may cause injury, since the fan may be rotating at high speeds.
- **Do not** use flammable sprays such as hair spray, lacquer or paint near the unit. This may cause fire or combustion.
- **Do not** store gasoline or flammable substances near air conditioner. Emitted gas may collect around the unit and cause explosion.
- **Do not** install your air conditioner in a wet room such as a bathroom or laundry room. Too much exposure to water can cause electrical components to short circuit.
- **Do not** expose your body directly to cool air for a prolonged period of time.
- **Do not** allow children to play with the air conditioner. Children must be supervised around the unit at all times.
- If the air conditioner is used together with burners or other heating devices, thoroughly ventilate the room to avoid oxygen deficiency and carbon monoxide build up.
- In certain environments, such as kitchens, server rooms, etc., the use of specially designed air-conditioning units is highly recommended.
- Improper installation, adjustment, alteration, service or maintenance can cause property damage, personal injury or loss of life. Installation and service must be performed by a licensed professional HVAC installer or equivalent, service agency, or the gas supplier.

## WARNINGS FOR CLEANING AND MAINTENANCE

- Turn off the device and disconnect the power before cleaning. Failure to do so can cause electrical shock.
- **Do not** clean the air conditioner with excessive amounts of water.
- **Do not** clean the air conditioner with combustible cleaning agents. Combustible cleaning agents can cause fire or deformation.

## ELECTRICAL WARNINGS

- **Do not** share the electrical circuit with other appliances. This equipment requires a dedicated electrical circuit.
- The product must be properly grounded at the time of installation, or electrical shock may occur.
- For all electrical work, follow all local and national wiring standards, regulations, and the Installation Manual. Connect cables tightly, and clamp them securely to prevent external forces from damaging the terminal. Improper electrical connections can overheat and cause fire, and may also cause shock. All electrical connections must be made according to the Electrical Connection Diagram located on the panels of the indoor and outdoor units.
- All wiring must be properly arranged to ensure that the control board cover can close properly. If the control board cover is not closed properly, it can lead to corrosion and cause the connection points on the terminal to heat up, catch fire, or cause electrical shock.
- If connecting power to fixed wiring, an all-pole disconnection device must be incorporated in the fixed wiring in accordance with the wiring rules.

## CAUTION

- Turn off the air conditioner and disconnect the power if you are not going to use it for a long time.
- Make sure that water condensation can drain unhindered from the unit.
- **Do not** operate the air conditioner with wet hands. This may cause electric shock.
- **Do not** use device for any other purpose than its intended use.
- **Do not** climb onto or place objects on top of the outdoor unit.
- As with any mechanical equipment, contact with sharp sheet metal edges can result in personal injury. Take care while handling this equipment and wear gloves and protective clothing.

## WARNINGS FOR PRODUCT INSTALLATION

- Installation must be performed by an authorized dealer or specialist. Defective installation can cause water leakage, electrical shock, or fire.
- Installation must be performed according to the installation instructions. Improper installation can cause water leakage, electrical shock, or fire.  
(In North America, installation must be performed in accordance with the requirement of NEC and CEC by authorized personnel only.)
- Contact an authorized service provider for repair or maintenance of this unit. This appliance shall be installed in accordance with national wiring regulations.
- Only use the included accessories, parts, and specified parts for installation. Using non-standard parts can cause water leakage, electrical shock, fire, and can cause the unit to fail.
- Install the unit in a firm location that can support the unit's weight. If the chosen location cannot support the unit's weight, or the installation is not done properly, the unit may fall and cause serious injury and damage.
- Install drainage piping according to the instructions in this manual. Improper drainage may cause water damage to your home and property.
- **Do not** install the unit in a location that may be exposed to combustible gas leaks. If combustible gas accumulates around the unit, it may cause fire.
- Do not turn on the power until all work has been completed.
- When moving or relocating the air conditioner, consult experienced service technicians for disconnection and reinstallation of the unit.
- Unit must be properly supported and secured to prevent tipping of unit.
- Excessive Weight Hazard - Use two or more people when moving and installing the unit. Failure to do so can result in back or other type of injury.

## TAKE NOTE OF FUSE SPECIFICATIONS

The air conditioner's circuit board (PCB) is designed with a fuse to provide overcurrent protection. This fuse must be replaced with an identical component. The specifications of the fuse are printed on the circuit board, examples of such are T5A/250VAC and T10A/250VAC.

### **Note:**



The machine you purchased may be one of the types in the table below. The indoor and outdoor units are designed to be used together. Please check the machine you purchased. You can also find the model of the machine you purchased on the packaging box of the machine.

<b>Products series</b>	<b>Model</b>	<b>Indoor unit</b>	<b>Outdoor unit</b>
2GenAHU 24V	24K(208/230V)	MCD18/24B1A	CMA1512SA-1
2GenAHU 24V	24K(208/230V)	MCD18/24B1A	CMA1518SA-1
2GenAHU 24V	36K(208/230V)	MCD30/36C1A	CMA1524SA-1
2GenAHU 24V	36K(208/230V)	MCD30/36B1A	CMA1530SA-1
2GenAHU 24V	48K(208/230V)	MCD48C1A	CMA1536SA-1
2GenAHU 24V	60K(208/230V)	MCD60D1A	CMA1548SA-1

# ACCESSORIES

The air conditioning system comes with the following accessories. Use all of the installation parts and accessories to install the air conditioner. Improper installation may result in water leakage, electrical shock and fire, or equipment failure.

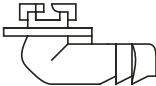
## Accessories (Packed with the indoor unit)

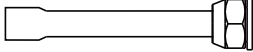
Name	Shape	Quantity
Drain fitting (some models)		1
Gasket (some models)		1
Flare-to-braze adapter(some models)		2

# REFRIGERANT PIPING CONNECTION

## Safety Precautions

### WARNING

- All field piping must be completed by a licensed technician and must comply with the local and national regulations.
- When the air conditioner is installed in a small room, measures must be taken to prevent the refrigerant concentration in the room from exceeding the safety limit in the event of refrigerant leakage. If the refrigerant leaks and its concentration exceeds its proper limit, hazards due to lack of oxygen may result.
- When installing the refrigeration system, ensure that air, dust, moisture or foreign substances do not enter the refrigerant circuit. Contamination in the system may cause poor operating capacity, high pressure in the refrigeration cycle, explosion or injury.
- Ventilate the area immediately if there is refrigerant leakage during the installation. Leaked refrigerant gas is both toxic and flammable. Ensure there is no refrigerant leakage after completing the installation work.

## Notes on pipe length and elevation

Ensure that the length of the refrigerant pipe, the number of bends, and the drop height between the indoor and outdoor units meets the requirements shown in the following table:

**The Maximum Length and Drop Height Based on Models. (Unit: m/ft.)**

Type of model	Capacity (Btu/h)	Length of piping	Maximum drop height
North America, Australia and the EU frequency conversion Split Type.	<15K	25/82	10/32.8
	≥15K - <24K	30/98.4	20/65.6
	≥24K - <36K	50/164	25/82
	≥36K - ≤60K	65/213	30/98.4

### CAUTION

#### Oil traps

If oil flows back into the outdoor unit's compressor, this might cause liquid compression or deterioration of oil return. Oil traps in the rising gas piping can prevent this.

An oil trap should be installed every 6m (20ft) of vertical suction line riser (<36000Btu/h unit).

An oil trap should be installed every 10m (32.8ft) of vertical suction line riser (≥36000Btu/h unit).

Name	Shape	Quantity (PC)	
Connecting pipe assembly	Liquid side	Ø6.35mm (1/4in)	The correct connecting pipes are included with your equipment.
		Ø9.52mm (3/8in)	
	Gas side	Ø12.7mm (1/2in)	
		Ø16mm (5/8in)	
		Ø19mm (3/4in)	
		Ø22mm (7/8in)	

Air Handler Unit Model	Air Handler Unit Connection (in. flare)		Adapter Required at Air Handler Unit (in. flare to braze)	Outdoor Model	Outdoor Unit Connection (in. flare)		Adapter Required at Outdoor Unit (in. flare to flare or braze)
18K/24K	Liquid	3/8	3/8flare → 3/8braze	18K/24K	Liquid	3/8	3/8flare → 3/8braze
	Gas	3/4	3/4flare → 3/4braze		Gas	5/8	5/8flare → 3/4flare 5/8flare → 3/4braze
24K/30K/36K/48K	Liquid	3/8	3/8flare → 3/8braze	24K (Hyper Heat)/30K/36K/48K	Liquid	3/8	3/8flare → 3/8braze
	Gas	3/4	3/4flare → 3/4braze		Gas	3/4	3/4flare → 3/4braze
60K	Liquid	3/8	3/8flare → 3/8braze	60K	Liquid	3/8	3/8flare → 3/8braze
	Gas	7/8	7/8flare → 7/8braze		Gas	7/8	7/8flare → 7/8braze

## Connection Instructions—Refrigerant Piping

### ⚠ CAUTION

- The branching pipe must be installed horizontally. An angle of more than 10° may cause malfunction.
- **DO NOT** install the connecting pipe until both indoor and outdoor units have been installed.
- Insulate both the gas and liquid piping to prevent condensation.

### Step 1: Cut pipes

When preparing refrigerant pipes, take extra care to cut and flare them properly. This will ensure efficient operation and minimize the need for future maintenance.

- Measure the distance between the indoor and outdoor units.
- Using a pipe cutter, cut the pipe a little longer than the measured distance.
- Make sure that the pipe is cut at a perfect 90° angle.

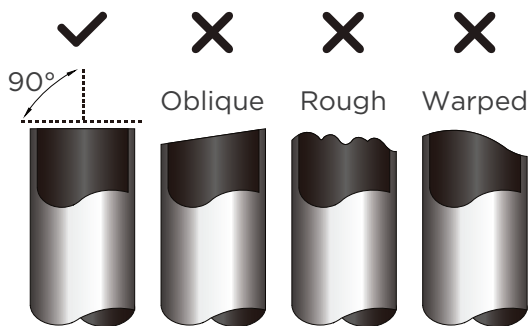

### 💡 DO NOT DEFORM PIPE WHILE CUTTING

Be extra careful not to damage, dent, or deform the pipe while cutting. This will drastically reduce the heating

### Step 2: Remove burrs

Burrs can affect the air-tight seal of refrigerant piping connection. They must be completely removed.

- Hold the pipe at a downward angle to prevent burrs from falling into the pipe.
- Using a reamer or deburring tool, remove all burrs from the cut section of the pipe.

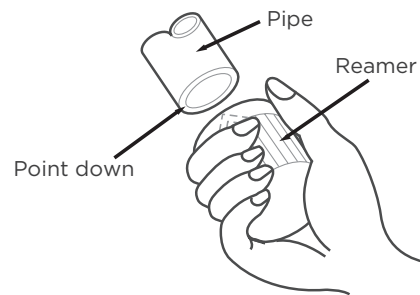

### Step 3: Flare pipe ends

Proper flaring is essential to achieve an airtight seal.

- After removing burrs from cut pipe, seal the ends with PVC tape to prevent foreign materials from entering the pipe.
- Sheath the pipe with insulating material.
- Place flare nuts on both ends of pipe. Make sure they are facing in the right direction, because you can't put them on or change their direction after flaring.

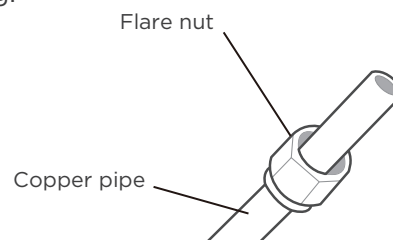

- Remove PVC tape from ends of pipe when ready to perform flaring work.

- Clamp flare form on the end of the pipe. The end of the pipe must extend beyond the flare form.

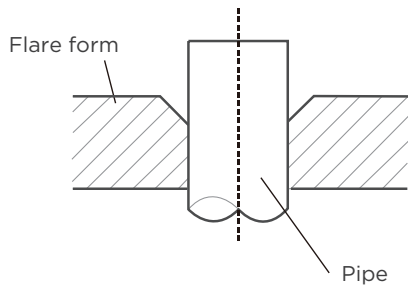

- Place flaring tool onto the form.
- Turn the handle of the flaring tool clockwise until the pipe is fully flared.

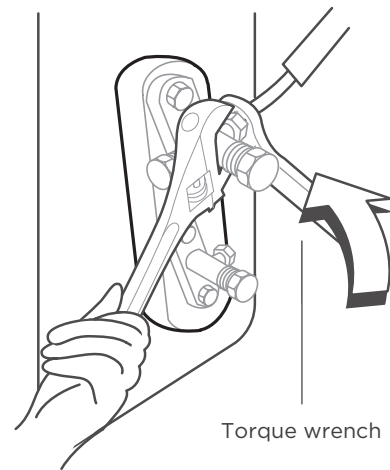

### PIPING EXTENSION BEYOND FLARE FORM

Pipe gauge	Tightening torque	Flare dimension (A) (Unit: mm/inch)		Flare shape
		Min.	Max.	
Ø6.35mm (Ø1/4in)	18-20 N·m (180-200kgf·cm)	8.4/0.33	8.7/0.34	
Ø9.52mm (Ø3/8in)	32-39 N·m (320-390kgf·cm)	13.2/0.52	13.5/0.53	
Ø12.7mm (Ø1/2in)	49-59 N·m (490-590kgf·cm)	16.2/0.64	16.5/0.65	
Ø16mm (Ø5/8in)	57-71 N·m (570-710kgf·cm)	19.2/0.76	19.7/0.78	
Ø19mm (Ø3/4in)	67-101 N·m (670-1010kgf·cm)	23.2/0.91	23.7/0.93	
Ø22mm (Ø7/8in)	85-110 N·m (850-1100kgf·cm)	26.4/1.04	26.9/1.06	

- Remove the flaring tool and flare form, then inspect the end of the pipe for cracks and even flaring.

### Step 4: Connect pipes

Connect the copper pipes to the indoor unit first, then connect it to the outdoor unit. You should first connect the low-pressure pipe, then the high-pressure pipe.

- When connecting the flare nuts, apply a thin coat of refrigeration oil to the flared ends of the pipes.
- Align the center of the two pipes that you will connect.
- Tighten the flare nut snugly by hand.
- Using a wrench, grip the nut on the unit tubing.
- While firmly gripping the nut, use a torque wrench to tighten the flare nut according to the torque values in above table.

### NOTICE

Use both a spanner and a torque wrench when connecting or disconnecting pipes to/from the unit.

### CAUTION

Ensure to wrap insulation around the piping. Direct contact with the bare piping may result in burns or frostbite.

- Make sure the pipe is properly connected. Over tightening may damage the bell mouth and under tightening may lead to leakage.

### NOTICE

#### MINIMUM BEND RADIUS

Carefully bend the tubing in the middle according to the diagram below.

**DO NOT** bend the tubing more than 90° or more than 3 times.

Use care when bending pipe, do not kink pipe.

Use appropriate tool

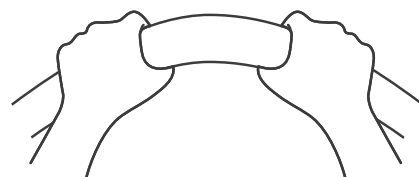

min-radius 10cm (3.9")

- After connecting the copper pipes to the indoor unit, wrap the power cable, signal cable and the piping together with binding tape.

### NOTICE

**DO NOT** intertwine signal cable with other wires. While bundling these items together.

**DO NOT** intertwine or cross the signal cable with any other wiring.

# OUTDOOR UNIT INSTALLATION

## NOTICE

Install the unit by following local switches and regulations, there may be differ slightly between different regions.

## Select the installation location of outdoor units

Before installing the outdoor unit, you must choose an appropriate location. The following are standards that will help you choose an appropriate location for the unit.

### Proper installation locations meet the following standards:

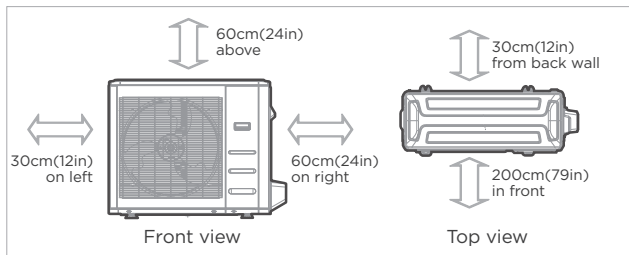

- Meets all spatial requirements shown in Installation Space Requirements above.



- Firm and solid—the location can support the unit and will not vibrate.



- Noise from the unit will not disturb other people.

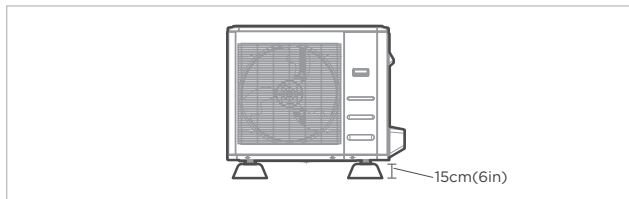

- The outdoor unit must be installed on risers of at least 15cm(6in) in height or per local code to get unit above local mean snow fall.



- Good air circulation and ventilation.

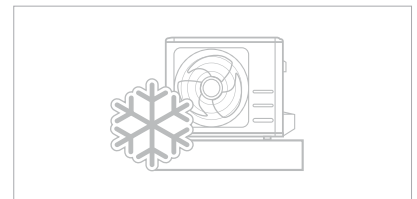

- Where snowfall is anticipated, take appropriate measures to prevent ice buildup and coil damage.

### DO NOT install unit in the following locations:

- Near an obstacle that will block air inlets and outlets.
- In a location that is exposed to large amounts of dust.
- Near animals or plants that will be harmed by hot air discharge.
- Near any source of combustible gas.
- Near a public street, crowded areas, or where noise from the unit will disturb others.

## CAUTION:

### SPECIAL CONSIDERATIONS FOR EXTREME WEATHER

#### If the unit is exposed to heavy wind:

Install unit so that air outlet fan is at a 90° angle to the direction of the wind. If needed, build a barrier in front of the unit to protect it from extremely heavy winds. See Figures below.

#### If the unit is frequently exposed to heavy rain or snow:

Build a shelter above the unit to protect it from the rain or snow. Be careful not to obstruct air flow around the unit.

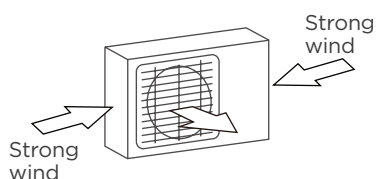

90° angle to the direction of the wind

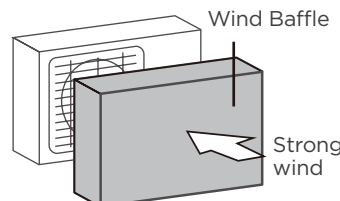

Build a wind Baffle to protect the unit

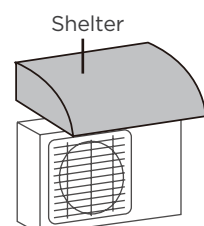

Build a shelter to protect the unit

## Install drain fitting (Heat pump unit only)

Before bolting the outdoor unit in place, you must install the drain joint at the bottom of the unit.

Note that there are two different types of drain joints depending on the type of outdoor unit.

**If the drain joint comes with a rubber seal (see Fig. A), do the following:**

1. Fit the rubber seal on the end of the drain joint that will connect to the outdoor unit.
2. Insert the drain joint into the hole in the base pan of the unit.
3. Rotate the drain joint 90° until it clicks in place facing the front of the unit.
4. Connect a drain hose extension (not included) to the drain joint to redirect water from the unit during heating mode.

**If the drain joint doesn't come with a rubber seal (see Fig. B), do the following:**

1. Insert the drain joint into the hole on the base pan, press firmly to ensure it is properly installed and will not become loose.
2. Connect a drain hose extension (not included) to the drain joint to redirect water from the unit during heating mode.

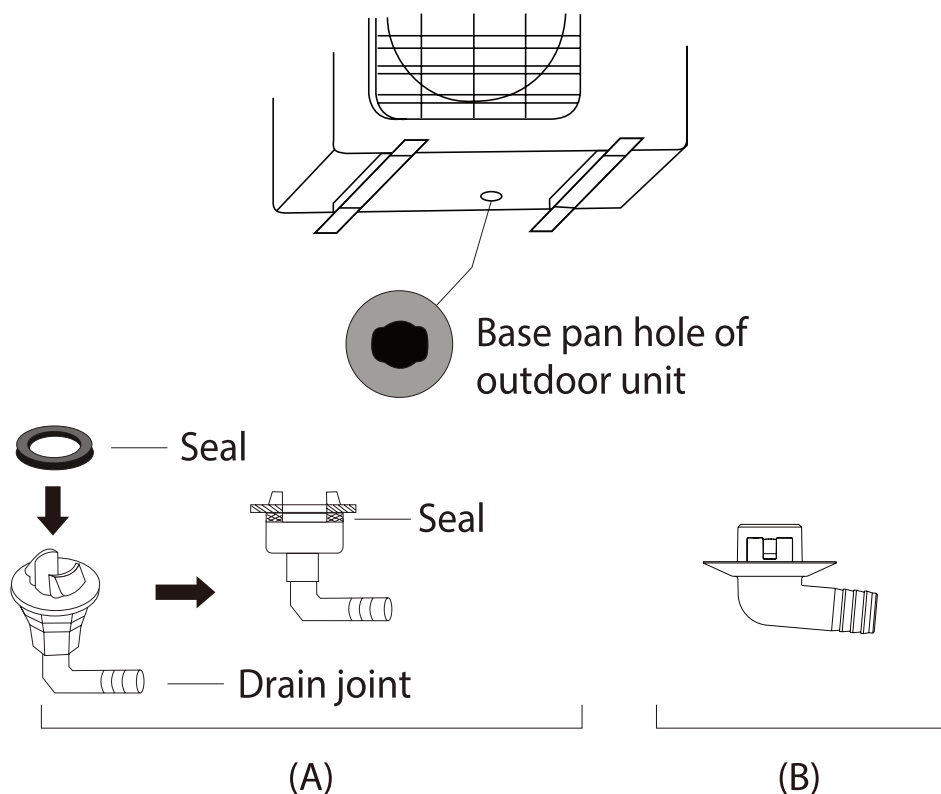

### ! IN COLD CLIMATES

In cold climates, make sure that the drain hose is as vertical as possible to ensure swift water drainage. If water drains too slowly, it can freeze in the hose and flood the unit.

## Anchor outdoor unit

The outdoor unit can be anchored to the ground or to a wall-mounted bracket with bolt(M10). Prepare the installation base of the unit according to the dimensions below.

### Outdoor Unit Types and Specifications

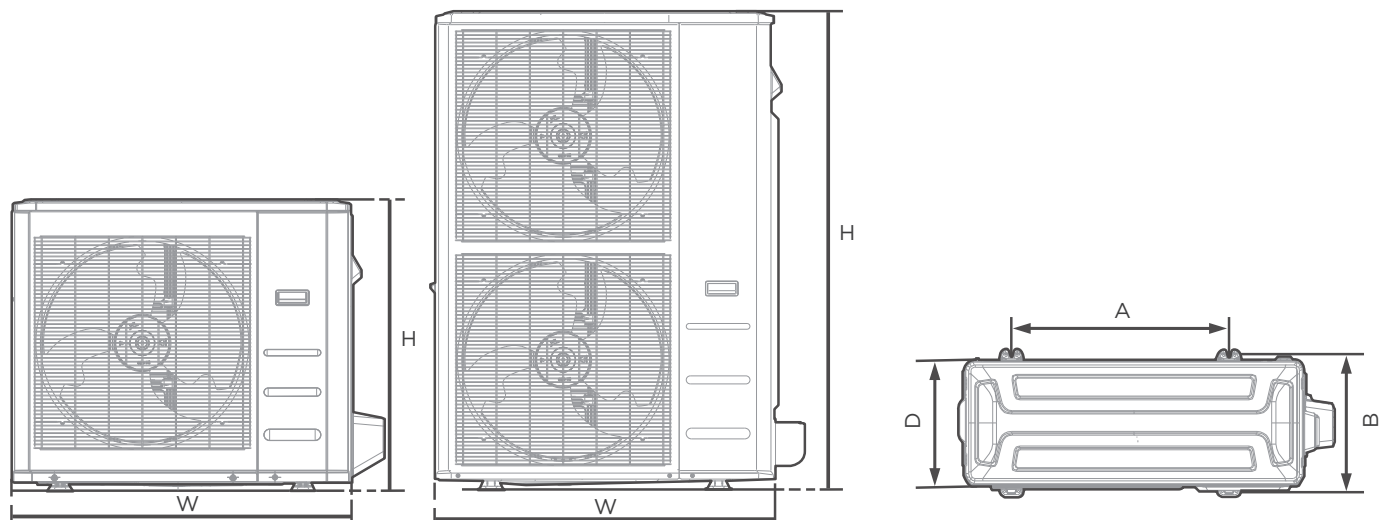

Front view

Top view

Outdoor Unit Dimensions						Mounting Dimensions			
W		H		D		A		B	
mm	inch	mm	inch	mm	inch	mm	inch	mm	inch
805	31-11/16	554	21-13/16	330	13	511	20-1/8	317	12-1/2
890	35	673	26-1/2	342	13-15/32	663	26-1/8	354	13-15/16
946	37-1/4	810	31-29/32	410	16-5/32	673	26-1/2	403	15-7/8
952	37-1/2	1333	52-1/2	415	16-11/32	634	24-35/36	404	15-29/32
980	38-19/32	975	38-13/32	410	16-5/32	616	24-1/4	397	15-5/8

(unit: mm/inch)

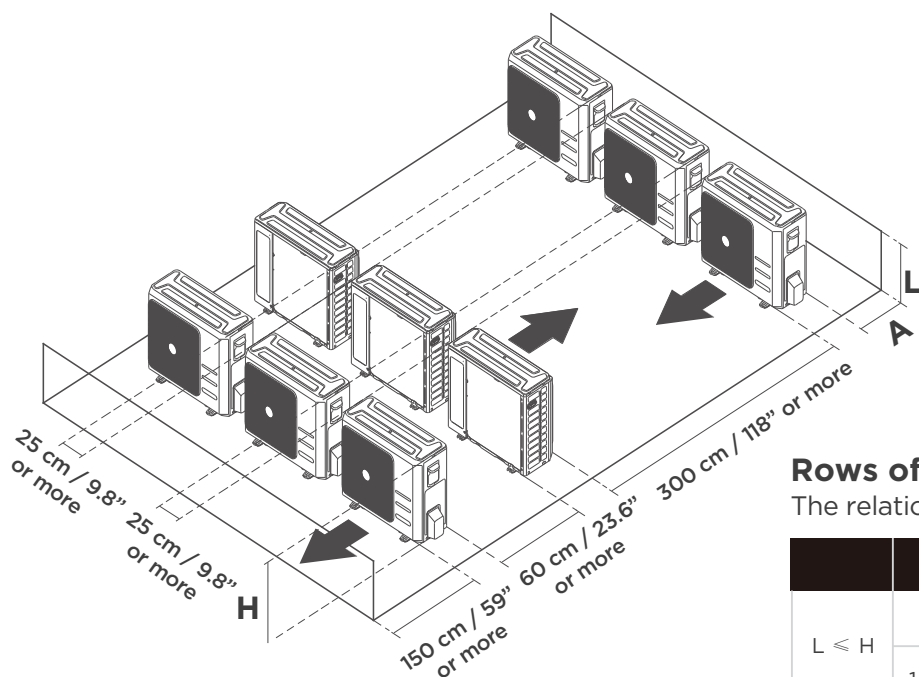

### Rows of series installation

The relations between H, A and L are as follows.

	L	A
L ≤ H	L ≤ 1/2H	25 cm / 9-13/16in or more
	1/2H < L ≤ H	30 cm / 11-13/16in or more
L > H	Cannot be installed	

**If you will install the unit on the ground or on a concrete mounting platform, DO THE FOLLOWING:**

- Mark the positions for four expansion bolts based on dimensions chart.
- Pre-drill holes for expansion bolts.
- Place a nut on the end of each expansion bolt.
- Hammer expansion bolts into the pre-drilled holes.
- Remove the nuts from expansion bolts, and place outdoor unit on bolts.
- Put washer on each expansion bolt, then replace the nuts.
- Using a wrench, tighten each nut until snug.

** WARNING**

WHEN DRILLING INTO CONCRETE, EYE PROTECTION IS RECOMMENDED AT ALL TIMES.

**If you will install the unit on a wall-mounted bracket, DO THE FOLLOWING:**

- Mark the position of bracket holes based on dimensions chart.
- Pre-drill the holes for the expansion bolts.
- Place a washer and nut on the end of each expansion bolt.
- Thread expansion bolts through holes in mounting brackets, put mounting brackets in position, and hammer expansion bolts into the wall.
- Check that the mounting brackets are level.
- Carefully lift unit and place its mounting feet on brackets.
- Bolt the unit firmly to the brackets.
- If allowed, install the unit with rubber isolator pads to reduce vibrations and noise.

** CAUTION**

Make sure that the wall is made of solid brick, concrete, or of similarly strong material. The wall must be able to support at least four times the weight of the unit.

# WIRING PRECAUTIONS

## WARNING

BEFORE PERFORMING ANY ELECTRICAL WORK, READ THESE WARNINGS.

- All wiring must comply with local and national electrical codes, regulations and must be installed by a licensed electrician.
- All electrical connections must be made according to the Electrical Connection Diagram located on the panels of the indoor and outdoor units.
- If there is a serious safety issue with the power supply, stop work immediately. Explain your reasoning to the client, and refuse to install the unit until the safety issue is properly resolved.
- Power voltage should be within 90-110% of rated voltage. Insufficient power supply can cause malfunction, electrical shock, or fire.
- Installation of an external surge suppressor at the outdoor disconnect is recommended.
- Power must be connected, a switch or circuit breaker that disconnects all poles and has a contact separation of at least 1/8in (3mm) must be incorporated in the fixed wiring. The qualified technician must use an approved circuit breaker or switch.
- Only connect the unit to an individual branch circuit. Do not connect another appliance to that circuit.
- Make sure to properly ground the air conditioner.
- Every wire must be firmly connected. Loose wiring can cause the terminal to overheat, resulting in product malfunction and possible fire.
- Do not let wires touch or rest against refrigerant tubing, the compressor, or any moving parts within the unit.
- To avoid getting an electric shock, never touch the electrical components soon after the power supply has been turned off. After turning off the power, always wait 10 minutes or more before you touch the electrical components.
- Make sure that you do not cross your electrical wiring with your signal wiring.
- This may cause distortion, interference or possibly damage to circuit boards.
- Connect the outdoor wires before connecting the indoor wires.

## WARNING

BEFORE PERFORMING ANY ELECTRICAL OR WIRING WORK, TURN OFF THE MAIN POWER TO THE SYSTEM.

# OUTDOOR UNIT WIRING

## ⚠ WARNING

Before performing any electrical or wiring work, turn off the main power to the system.

### Step 1: Prepare the cable for connection.

1. You must first choose the right cable size.
2. Using wire strippers, strip the jacket from both ends of the signal cable to reveal approximately 15cm (5.9") of wire.
3. Strip the insulation from the ends.
4. Stranded wire requires u-lugs or ring terminals to be crimped onto the ends of the wire.

## 💡 NOTICE

- When connecting the wires, strictly follow the wiring diagram found inside the electrical box cover.
- Choose the cable type according to the local electrical switches and regulations.
- Please choose the right cable size according to the Minimum Circuit Ampacity indicated on the nameplate of the unit.

### Step 2: Remove the electric cover.

Remove the electric cover of the outdoor unit.

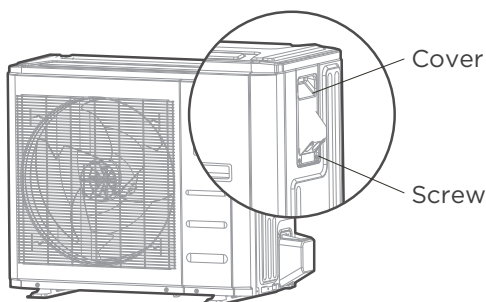

### Step 3: Connect the u-lugs to the terminals

Match the wire colors/labels with the labels on the terminal block. Firmly screw the u-lug of each wire to its corresponding terminal.

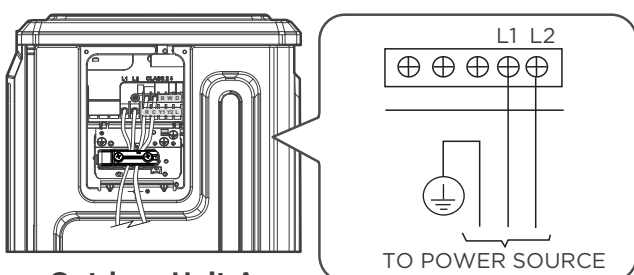

Outdoor Unit A

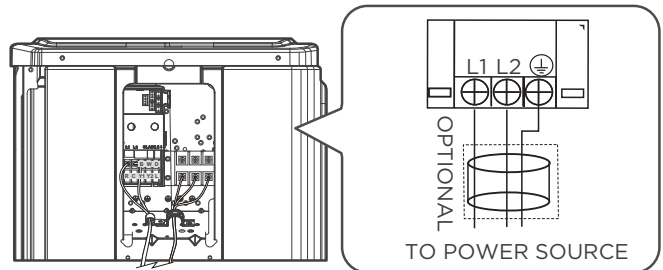

Outdoor Unit B

1. Clamp down the cable with the cable clamp.
2. Insulate unused wires with electrical tape. Keep them away from any electrical or metal parts.
3. Reinstall the cover of the electric control box.

### In North America

1. Remove the wire cover from the unit by loosening the 3 screws.
2. Remove caps on the conduit panel.
3. Mount the conduit tubes (not included) on the conduit panel.
4. Properly connect both the power supply and low voltage lines to the corresponding terminals on the terminal block.
5. Ground the unit in accordance with local codes.
6. Be sure to size each wire allowing several inches longer than the required length for wiring.

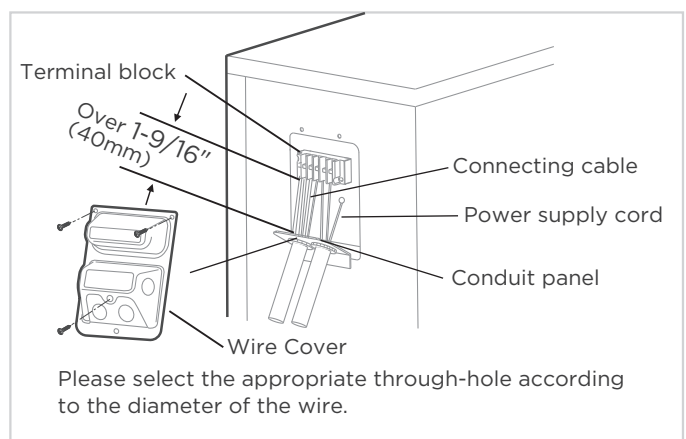

## ⚠ WARNING

ISOLATE THE POWER SUPPLY LEADS AND COMMUNICATION LEADS BY THE STRAIN RELIEF AND KEEP POWER SUPPLY LEADS AWAY FROM COMMUNICATION LEADS. DISCONNECTION MUST BE INCORPORATED IN THE FIXED WIRING IN ACCORDANCE WITH THE WIRING RULES.

# SPECIFIC WIRING METHODS

## ⚠ WARNING

Please refer to the wiring nameplate for the wiring method. Do not connect 24V AC to S1 - S2, as this will damage the system.

### Connection method A:

This is the preferred method of control with the communicating control, Midea indoor and outdoor unit. Refer to the wiring method of internal and external machine communication and wired controller as follows:

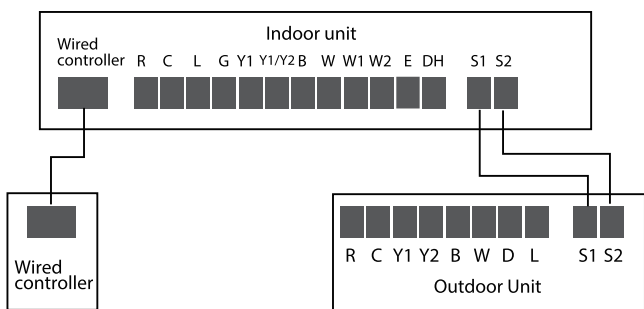

### Connection method B:

To use a 24V thermostat, you need to refer to the following wiring:

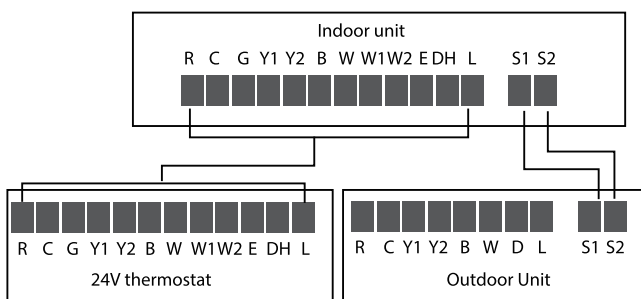

When using a 24V thermostat, please refer to the non-communicating wiring diagrams that follow:

### Connection method C:

#### 💡 NOTICE

This equipment uses B functionality. This terminal is energized for heating functionality. Please ensure that thermostat configuration is set up for B functionality.  
 Note: These methods are for use with a Midea outdoor unit and a third party indoor unit or cased coil and gas furnace.

## 24V communication

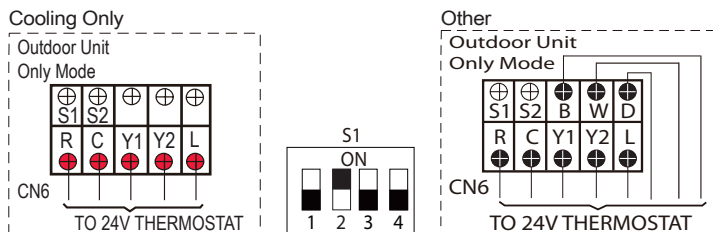

24V must never be connected to S1 - S2. All wiring must be in compliance with the above scenarios. Incorrect wiring will cause irreversible damage to control.

### 24V connection Dip Switch setting as shown in the picture:

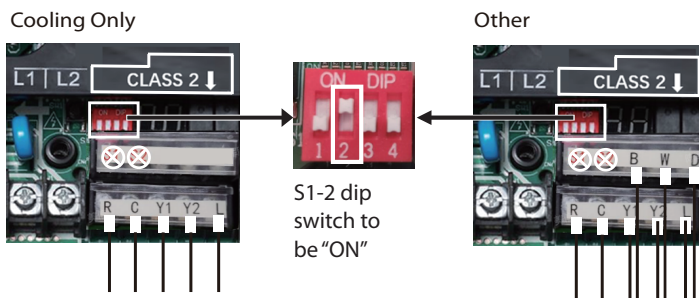

#### 💡 NOTICE

The use of shielded communication or thermostat wire is not required, but is recommended where separation from high voltage conductors can not be maintained, or in areas with high electrical noise. The shield and drain conductor must be grounded at the outdoor unit and stripped back and taped at the indoor unit. Grounding at both ends results in an increase of noise transmitted onto the signal wires.

## Outdoor unit DIP Switch setting

Press the SW1 button 10S for force defrosting

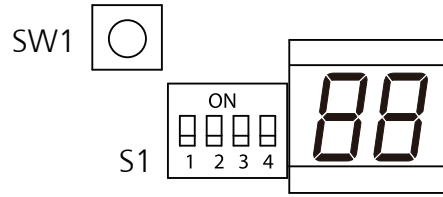

NO.	Dial code	Features	ON	OFF
1	S1-1	Function to be defined		
2	S1-2	Communication dial code	24V communication scheme	485 communication scheme
3	S1-3	Strong cold and strong heat function	The cooling/heating target pressure compensation value is valid	The cooling/heating target pressure compensation value is invalid
4	S1-4	Enhanced defrosting function	Enhanced defrosting	Default setting(standard defrost algorithm)

## SPECIFIC WIRING METHODS

### NOTICE

The following wiring diagram are suitable for the AHU and ODU with 24V thermostat.

### Non-communication scheme wiring reference

#### • Wiring for 4H and 2C thermostat

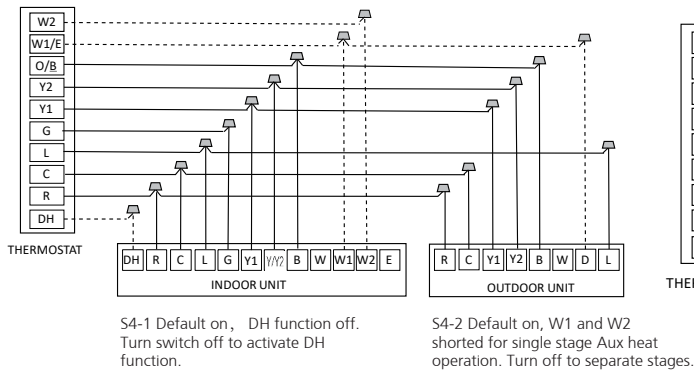

#### • Wiring for 3H and 2C thermostat

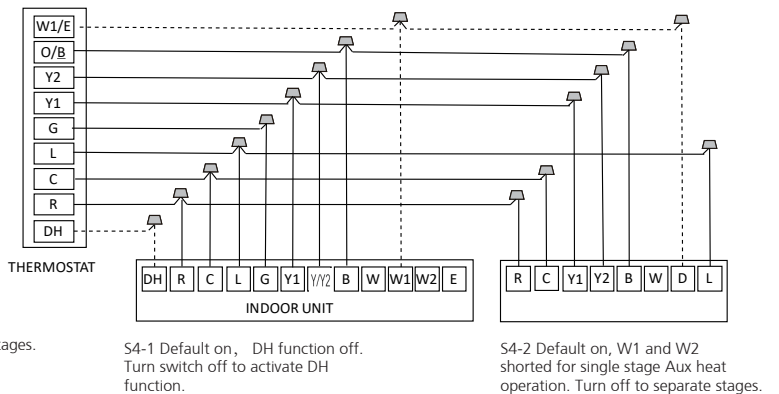

#### • Wiring for 3H and 1C thermostat

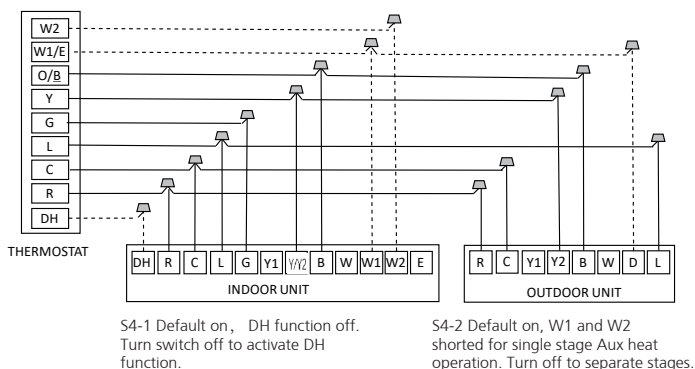

#### • Wiring for 2H and 2C thermostat

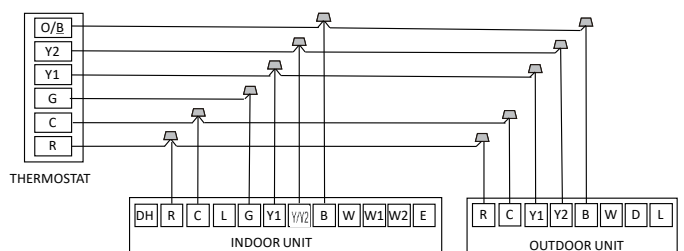

• Wiring for 3H and 2C thermostat

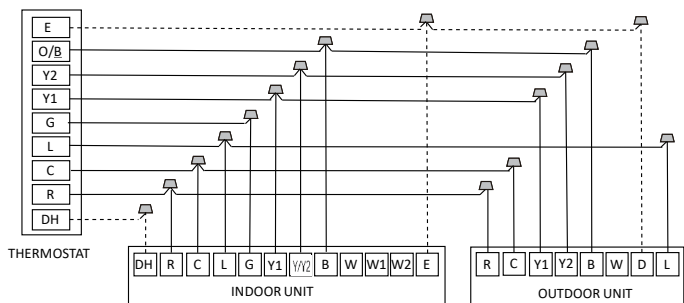

S4-1 Default on, DH function off. Emergency heating control two groups of electric heating at the same time function. Turn switch off to activate DH

**Control logic**

**Indoor unit connector**

Connector	Purpose
R	24V power Connection
C	Common
Y1	Low Cooling
Y2	Heat Cooling
B	Heating Reversing Valve
W	Heating control
D	Defrost control
L	System Fault Signal

**LED display**

The control displays unit status as well as any active fault codes on the LED display. If the unit is functioning normally, the LED will display current temperature setpoint. When a fault code is active, the display will flash the active fault code. Please refer to the fault code table located in the troubleshooting section of the Service Manual for detailed fault code information.

• Wiring for 2H and 1C thermostat

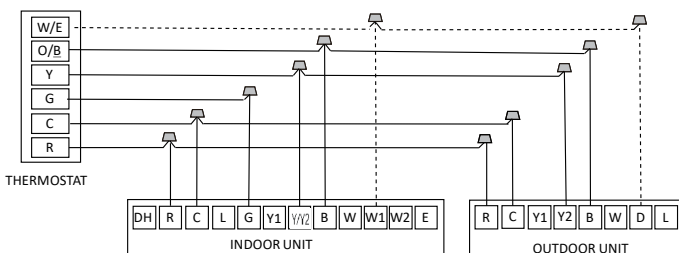

S4-2 Default on, W1 and W2 shorted for single stage Aux heat operation. Turn off to separate stages.

• Wiring for 1H and 1C thermostat

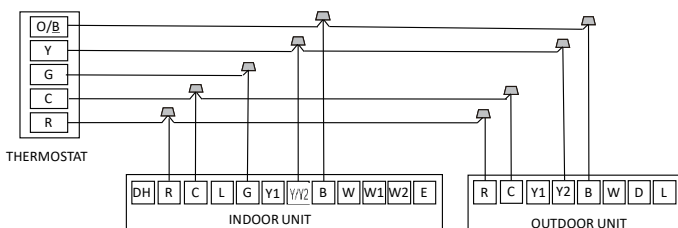

• Wiring for 1H and 1C thermostat

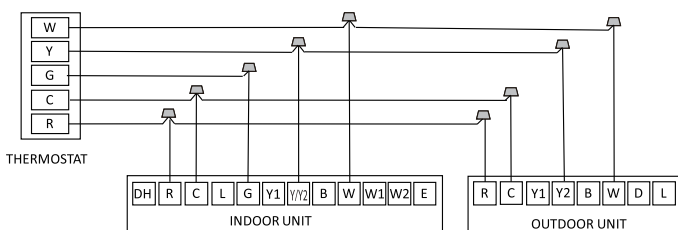

**NOTICE**

This is the least preferred method of control wiring and should only be used for emergency situations. Full comfort capacity may not be achieved using this method.

# SPECIFICATIONS

## Cooling and Heating power specifications

MODEL(Btu/h)			18K		24K		30K	
POWER (outdoor)	PHASE		1 Phase					
	FREQUENCY AND VOLT		208/230V,60Hz					
INPUT CIRCUIT FUSE	OUTDOOR UNIT(A)	MCA	Std	Hyper HT	Std	Hyper HT	Std	Hyper HT
		MOP	16 / 16	20 / 20	19 / 20	30 / 35	20 / 23	35 / 35
LINES GAUGE	OUTDOOR UNIT POWER LINE	LINE QUANTITY						
		2+Ground						
	LINE DIAMETER(AWG)	STD	12	STD	12	STD	12	
		HH	12	HH	12	HH	10	
	OUTDOOR-INDOOR SIGNAL LINE	LINE QUANTITY						
		2						
THERMOSTAT SIGNAL LINE	LINE DIAMETER(AWG)							
	20							
THERMOSTAT SIGNAL LINE	LINE QUANTITY							
	---							
THERMOSTAT SIGNAL LINE	LINE DIAMETER(AWG)							
	18							

MODEL(Btu/h)			36K		36K(X6)		48K		60K	
POWER (outdoor)	PHASE		1 Phase							
	FREQUENCY AND VOLT		208/230V,60Hz							
INPUT CIRCUIT FUSE	OUTDOOR UNIT(A)	MCA	Std	Hyper HT	Hyper HT	Std	Hyper HT	Std	Hyper HT	
		MOP	24 / 41	40 / 50	30	35	34 / 42	50 / 50	34 / 40	60 / 50
LINES GAUGE	OUTDOOR UNIT POWER LINE	LINE QUANTITY								
		2+Ground								
	LINE DIAMETER(AWG)	STD	10	HH	10	STD	8	STD	8	
		HH	8	HH	10	HH	6	HH	8	
	OUTDOOR-INDOOR SIGNAL LINE	LINE QUANTITY								
		2								
THERMOSTAT SIGNAL LINE	LINE DIAMETER(AWG)									
	20									
THERMOSTAT SIGNAL LINE	LINE QUANTITY									
	---									
THERMOSTAT SIGNAL LINE	LINE DIAMETER(AWG)									
	18									

### NOTICE

Line Diameter Sizing per NFPA 70 (2020), Table 310.15 (B) (16) Based on type NM-B Romex wire. Other sizing options are possible. Consult NFPA 70 or Licensed Electrician for alternate sizing. Please follow the prompts on the nameplate of the machine body for actual parameters. Please follow the prompts on the nameplate of the machine body for actual parameters.

# AIR EVACUATION

## NOTICE

When opening valve stems, turn the hexagonal wrench until it hits against the stopper. Do not try to force the valve to open further.

Open valves slowly until you hear refrigerant, allow pressure to equalize before opening fully. Open large vapor line valve first.

## Preparations and precautions

Air and foreign matter in the refrigerant circuit can cause abnormal rises in pressure, which can damage the air conditioner, reduce its efficiency, and cause injury. Use a vacuum pump and manifold gauge to evacuate the refrigerant circuit, removing any non-condensable gas and moisture from the system. Evacuation should be performed upon initial installation and when unit is relocated.

### BEFORE PERFORMING EVACUATION

- ✓ Check to make sure the connective pipes between the indoor and outdoor units are connected properly.
- ✓ Check to make sure all wiring is connected properly.

## Evacuation Instructions

1. Connect the charge hose of the manifold gauge to service port on the outdoor unit's low-pressure valve.
2. Connect another charge hose from the manifold gauge to the vacuum pump.
3. Open the low-pressure side of the manifold gauge. Keep the high-pressure side closed.
4. Tighten refrigerant valve caps hand tight plus flat to ensure there are no vacuum leaks.
5. Turn on the vacuum pump to evacuate the system.

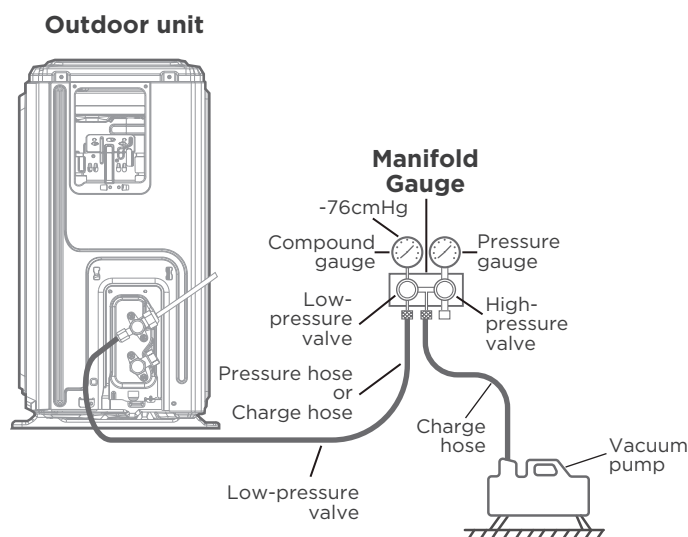

6. Run the vacuum for at least 15 minutes, or until the Compound Meter reads  $-76\text{cmHG}(-10^5\text{Pa})$  or 500 microns.
7. Close the low-pressure side of the manifold gauge, and turn off the vacuum pump.
8. Wait for 5 minutes, then check that there has been no change in system pressure.
9. If there is a change in system pressure, refer to Gas Leak Check section for information on how to check for leaks. If there is no change in system pressure, unscrew the cap from the packed valve (high-pressure valve).
10. Insert hexagonal wrench into the packed valve (high-pressure valve) and open the valve by turning the wrench in a 1/4 counterclockwise turn. Listen for gas to exit the system, then close the valve after 5 seconds.
11. Watch the Pressure Gauge for one minute to make sure that there is no change in pressure. The Pressure Gauge should read slightly higher than atmospheric pressure.
12. Remove the charge hose from the service port.

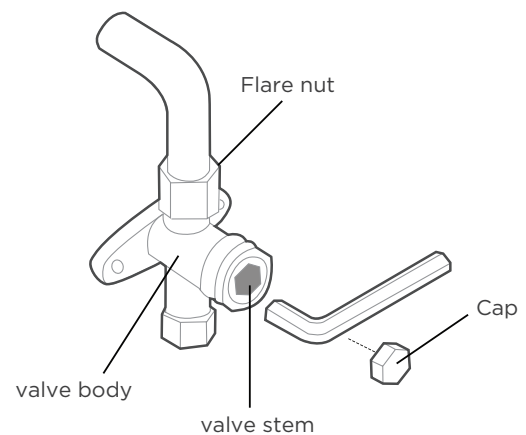

13. Using hexagonal wrench, fully open both the high-pressure and low-pressure valves.
14. Tighten all valve caps hand tight plus one flat to ensure no leaks. You may tighten it further using a torque wrench if needed.

# NOTE ON ADDING REFRIGERANT

## CAUTION

**DO NOT** mix refrigerant types.

Some systems require additional charging depending on pipe lengths. In North America, the standard pipe length is 25ft (7.5m). The refrigerant should be charged from the service port on the outdoor unit's low-pressure valve. The additional refrigerant to be charged can be calculated using the following formula:

Refrigerant	Liquid Side Diameter		
	Ø6.35mm (Ø1/4in)	Ø9.52mm (Ø3/8in)	Ø12.7mm (Ø1/2in)
<b>R410A:</b> (metering device in the indoor unit)	(Total pipe length – standard pipe length) x 30g (0.32oz)/m(ft)	(Total pipe length – standard pipe length) x 65g (0.69oz)/m(ft)	(Total pipe length – standard pipe length) x 115g (1.23oz)/m(ft)
<b>R410A:</b> (metering device in the outdoor unit)	(Total pipe length – standard pipe length) x 15g (0.16oz)/m(ft)	(Total pipe length – standard pipe length) x 30g (0.32oz)/m(ft)	(Total pipe length – standard pipe length) x 65g (0.69oz)/m(ft)

# TEST RUN

## CAUTION

Failure to perform the test run may result in unit damage, property damage, or personal injury.

### Before test run

A test run must be performed after the entire system has been completely installed. Confirm the following points before performing the test:

- a) Indoor and outdoor units are properly installed.
- b) Piping and wiring are properly connected.
- c) No obstacles near the inlet and outlet of the unit that might cause poor performance or product malfunction.
- d) Refrigeration system does not leak.
- e) Drainage system is unimpeded and draining to a safe location.
- f) Heating insulation is properly installed.
- g) Grounding wires are properly connected.
- h) Length of the piping and additional refrigerant capacity have been recorded.
- i) Power voltage is the correct voltage for the air conditioner

### Test run Instructions

1. Open both the liquid and gas service valves.
2. Turn on the main power switch and allow the unit to warm up.
3. Set the air conditioner to COOL mode.
4. For the Indoor Unit
  - a. Double check to see if the room temperature is being registered correctly.
  - b. Check to see that the drainage system is unimpeded and draining smoothly.
  - c. Ensure there is no vibration or abnormal noise during operation.

5. For the Outdoor Unit
  - a. Check to see if the refrigeration system is leaking.
  - b. Make sure there is no vibration or abnormal noise during operation.
  - c. Ensure the wind, noise, and water generated by the unit do not disturb your neighbors or pose a safety hazard.
6. Drainage Test
  - a. Ensure the drainpipe flows smoothly. New buildings should perform this test before finishing the ceiling.
  - b. Turn on the main power switch and run the air conditioner in COOL mode.
  - c. Check to see that the water is discharged. It may take up to one minute before the unit begins to drain depending on the drainpipe.
  - d. Make sure that there are no leaks in any of the piping.
  - e. Stop the air conditioner. Turn off the main power switch and reinstall the test cover.

## NOTICE

If the unit malfunctions or does not operate according to your expectations, please refer to the Troubleshooting section of Service Manual before calling customer service.

The design and specifications are subject to change without prior notice for product improvement. Consult with the sales agency or manufacturer for details. Any updates to the manual will be uploaded to the service website, please check for the latest version.





**LIMITED EXPRESS WARRANTY  
'CMA' SERIES HORIZONTAL/SIDE DISCHARGE CONDENSERS**

**Congratulations on purchasing your new HVAC equipment. It's been designed for long life and reliable service, and is backed by one of the strongest warranties in the industry. Your unit automatically qualifies for the warranty coverage listed below, providing you keep your proof of purchase (receipt) for the equipment and meet the warranty conditions.**

**LIMITED TWO (2) YEAR PARTS EXPRESS WARRANTY**

Heat Controller warrants all parts of the 'CMA' Series Condensing Unit to be free from defects in workmanship and materials normal use and maintenance for two (2) year from the date of purchase by the original consumer. This Express Limited Warranty applies only when the 'CMA' Series Condensing Unit is installed and operated per Heat Controller installation and operating instructions for normal use, and in accordance with all local, state and national codes.

**LIMITED FIVE (5) YEAR COMPRESSOR EXPRESS WARRANTY**

The compressor only is warranted to be free from defects in workmanship and materials under normal use and maintenance for four additional years, for a total of five (5) years from the date of purchase by the original consumer. This five year warranty applies only when the system is installed and operated per Heat Controller installation and operation instructions for normal use.

**COMMERCIAL USE—LIMITED TWO (2) YEAR PARTS WARRANTY**

When the unit is put to commercial, business, rental, or any application other than residential use, the Two Year Parts Limited Warranty as described in paragraph one is the only warranty that applies.

**EXCEPTIONS**

The Limited Express Warranty does not cover normal maintenance—Heat Controller recommends that regular inspection/maintenance be performed at least once a season and proof of maintenance be kept. Additionally, labor charges, transportation charges for replacement parts, replacement of refrigerant or filters, any other service calls/repairs are not covered by this Limited Warranty. It also does not cover any portion or component of the system that is not supplied by Heat Controller, regardless of the cause of failure of such portion or component.

**CONDITIONS FOR WARRANTY COVERAGE**

- Unit must be operated according to Heat Controller operating instructions included with the unit and cannot have been subjected to accident, alteration, improper repair, neglect or misuse, or an act of God (such as a flood)
- Installation was done by a trained, licensed or otherwise qualified HVAC dealer/contractor
- Performance cannot be impaired by use of any product not authorized by Heat Controller, or by any adjustments or adaptations to components
- Serial numbers and/or rating plate have not been altered or removed
- Damage has not been a result of inadequate wiring or voltage conditions, use during brown-out conditions, or circuit interruptions
- Air flow around any section of the unit has not been restricted
- Unit remains in the original installation
- Unit was not purchased over the internet

**DURATION OF WARRANTY & REGISTRATION**

The warranty begins on the date of purchase by the original consumer. The consumer must retain a receipted bill of sale as proof of warranty period. Without this proof, the express warranty begins on the date of shipment from the factory.

**REMEDY PROVIDED BY THE LIMITED EXPRESS WARRANTY**

The sole remedy under the Limited Warranty is replacement of the defective part. If replacement parts are required within the period of this warranty, Heat Controller replacement parts shall be used; any warranty on the replacement part(s) shall not affect the applicable original unit warranty. Ready access to the unit for service is the owner's responsibility. Labor to diagnose and replace the defective part is not covered by this Limited Express Warranty. If for any reason the replacement part/product is no longer available during the warranty period, Heat Controller/Heat Controller shall have the right to allow a credit in the amount of the current suggested retail price of the part/product instead of providing repair or replacement.

**LIMITATION OF LIABILITY**

1. There are no other express or implied warranties. Heat Controller makes no warranty of merchantability. We do not warrant that the unit is suitable for any particular purpose or can be used in buildings or rooms of any particular size or condition except as specifically provided in this document. There are no other warranties, express or implied, which extend beyond the description in this document.
2. All warranties implied by law are limited in duration to the one-year term of the parts warranty. Your exclusive remedy is limited to the replacement of defective parts. **We will not be liable for any consequential or incidental damages caused by any defect in this unit.**
3. This warranty gives you specific legal rights and you may also have other rights which vary from state to state. Some states do not allow limitation on how long an implied warranty lasts or do not allow the exclusion or limitation of incidental or consequential damages, so the above limitations or exclusions may not apply to you.
4. No warranties are made for units sold outside the continental United States and Canada. Your distributor or final seller may provide a warranty on units sold outside these areas.
5. Heat Controller will not be liable for damages if our performance regarding warranty resolution is delayed by events beyond our control including accident, alteration, abuse, war, government restrictions, strikes, fire, flood, or other acts of God.

**HOW TO OBTAIN WARRANTY SERVICE OR PARTS**

If you have a warranty claim, notify your installer promptly. If the installer does not remedy your claim, write to Heat Controller, 1900 Wellworth Ave., Jackson MI 49203. Enclose a report of inspection by your installer or service person. Include model number, serial number, and date of purchase.

**Owner responsibilities are set forth in the instruction manual—read it carefully.**

**KEEP THIS INFORMATION AS A RECORD OF YOUR PURCHASE**

**'CMA' SERIES HORIZONTAL/SIDE DISCHARGE CONDENSING UNIT**

_____	_____	_____
Model Number	Model Number	Installer Name
_____	_____	_____
Serial Number	Serial Number	Phone No./Contact Info
_____	_____	_____
Date of Purchase	Date Installation Completed	

**Remember to retain your bill of sale as proof of warranty period.**

Due to ongoing product improvements, specifications and dimensions are subject to change and correction without notice or incurring obligations. Determining the application and suitability for use of any product is the responsibility of the installer. Additionally, the installer is responsible for verifying dimensional data on the actual product prior to beginning any installation preparations.

Incentive and rebate programs have precise requirements as to product performance and certification. All products meet applicable regulations in effect on date of manufacture; however, certifications are not necessarily granted for the life of a product. Therefore, it is the responsibility of the applicant to determine whether a specific model qualifies for these incentive/rebate programs.

*Comfort-Cire*®  **Century**®