



**Installation and Operation Manual**

**EA448F**

Wall Sleeve for TTW Units

# THROUGH-THE-WALL AIR CONDITIONER SLEEVE INSTALLATION INSTRUCTIONS

## HOW TO ASSEMBLE THE WALL SLEEVE

### SLEEVE HARDWARE

ITEM	DESCRIPTION	QTY
1	TOP PANEL	1
2	BOTTOM PANEL	1
3	LEFT SIDE PANEL	1
4	RIGHT SIDE PANEL	1
5	FRONT COVER PANEL	1
6	REAR COVER PANEL	1
7	BRACKET	4
8	CLASP FOR SLEEVE	4
9	SCREW ST3.9*10	28
10	WASHER	8

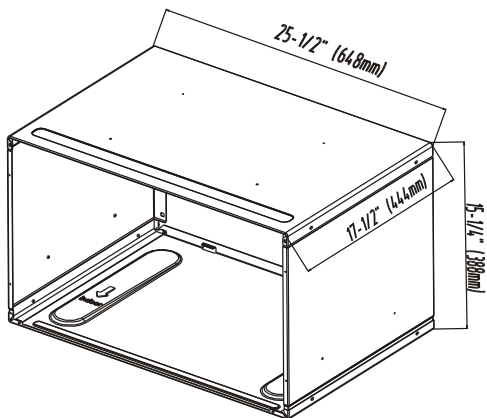
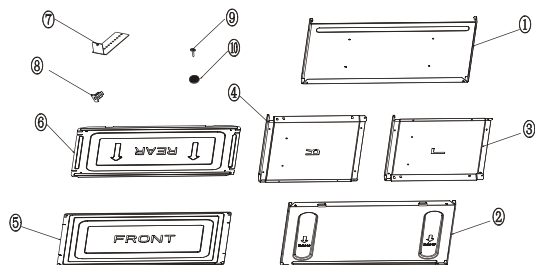

SLEEVE DIMENSION

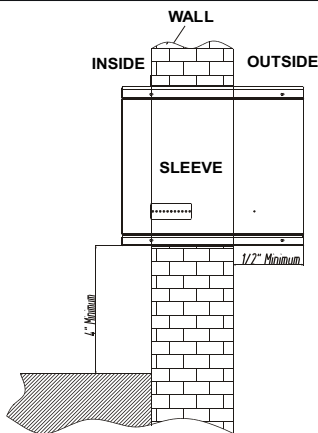

SLEEVE INSTALLATION

## INSTALL THE UNIT

- Remove the old air conditioner from the existing wall sleeve and remove the existing wall sleeve.
- Prepare and install the new wall sleeve into the wall opening.
- The wall sleeve must be fastened in the wall securely before installing the new air conditioner.
- Keep the cover panels for later use to protect the sleeve from rainy or windy weather.
- To avoid distortion to the front panel of the air conditioner, the sleeve should be installed at a distance of 4\"/>

## ASSEMBLE THE WALL SLEEVE

- Use four screws to fasten the side panels on the bottom panel as shown below.
- NOTE: The arrow marks on the bottom panel indicate the direction of indoor side

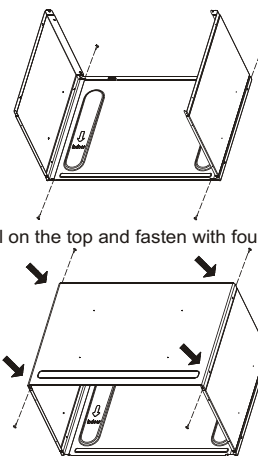

- Place the top panel on the top and fasten with four screws as shown below.

- Insert the four clasps for sleeve into the quadrate holes in the side panels as shown below.

### CLASP FOR SLEEVE

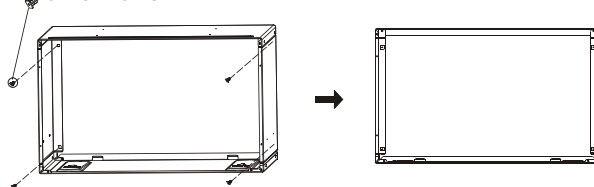

- Insert the louvered rear grille or the plastic rear grille (packed with air conditioner you purchased) and fasten with 4 washer screws as shown below.

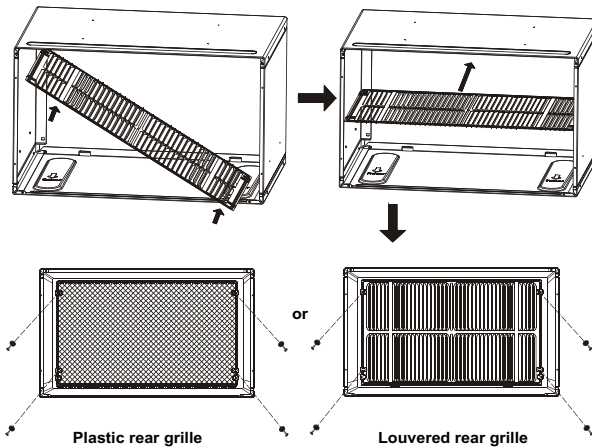

Plastic rear grille

Louvered rear grille

**ASSEMBLE THE WALL SLEEVE (CONTINUED)**

- Install two brackets on the top and one bracket on each side of the sleeve, fasten with four screws. There are two methods for your choice to install the brackets as shown in FIG. A and FIG.B.

NOTE: Choose any hole in the bracket you prefer to fasten the screws on to the sleeve.

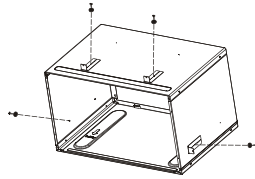

FIG.A

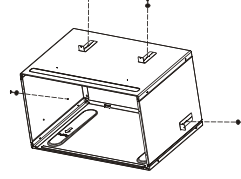
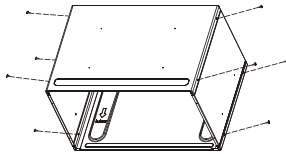
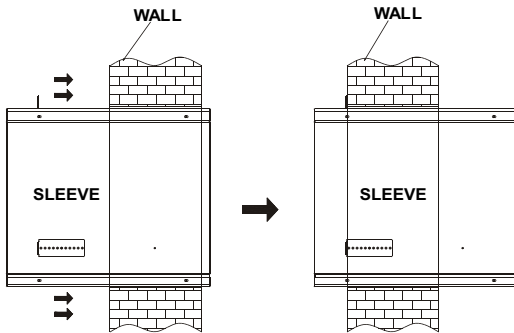

FIG.B

- NOTE: To improve the firmness of the sleeve, it is recommended to install 8 more screws as shown below.



- First put the assembled sleeve into the wall opening as shown below, then place the air conditioner into the sleeve.



**INSTALL THE COVER PANELS (when not using air conditioner for a long time.)**

- To install cover panel at the back of sleeve, first remove air conditioner from sleeve.
- Take the louvered rear grille or the plastic rear grille out by loosening the four washer screws as shown in FIG. C.
- From the inside of the sleeve, insert the rear cover panel and re-insert the four washer screws through the panel, then tighten them as shown in FIG. D and FIG. E.
- Use the front panel to cover the front of the sleeve. Fasten with 4 screws as shown in FIG. F.

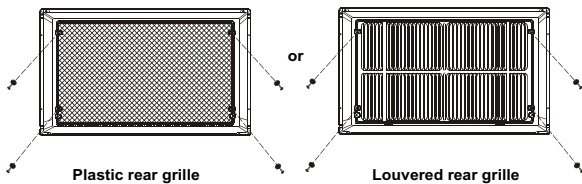

FIG.C

**INSTALL THE COVER PANELS (CONTINUED)**

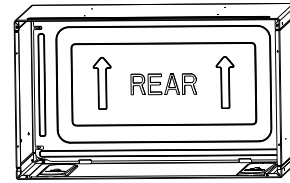

FIG.D

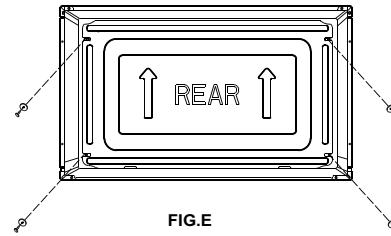

FIG.E

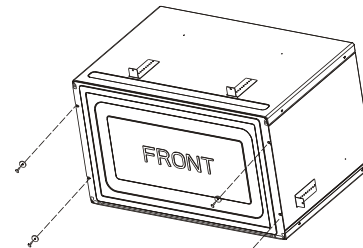

FIG.F

Minimum Rough Opening:  
25 3/4" Wide  
15 1/2" High

---

Due to ongoing product improvements, specifications and dimensions are subject to change and correction without notice or incurring obligations. Determining the application and suitability for use of any product is the responsibility of the installer. Additionally, the installer is responsible for verifying dimensional data on the actual product prior to beginning any installation preparations.

Incentive and rebate programs have precise requirements as to product performance and certification. All products meet applicable regulations in effect on date of manufacture; however, certifications are not necessarily granted for the life of a product. Therefore, it is the responsibility of the applicant to determine whether a specific model qualifies for these incentive/rebate programs.

*Comfort-Cire*<sup>®</sup>

1900 Wellworth Ave., Jackson, MI 49203 • Ph. 517-787-2100 • [www.heatcontroller.com](http://www.heatcontroller.com)