

---

*Comfort-Cure*®

**Century**®

---

**SMART KIT  
USER MANUAL**

**SSP Series**

---

517-787-2100

# **CONTENTS**

<b>1</b>	<b>SPECIFICATION.....</b>	<b>1</b>
<b>2</b>	<b>PRECAUTIONS .....</b>	<b>1</b>
<b>3</b>	<b>DOWNLOAD AND INSTALL APP.....</b>	<b>2</b>
<b>4</b>	<b>INSTALL THE SMART KIT (wireless module).....</b>	<b>3</b>
<b>5</b>	<b>USER REGISTRATION .....</b>	<b>6</b>
<b>6</b>	<b>NETWORK CONFIGURATION.....</b>	<b>8</b>
<b>7</b>	<b>HOW TO USE APP.....</b>	<b>19</b>
<b>8</b>	<b>SPECIAL FUNCTIONS.....</b>	<b>21</b>

## **DECLARATION OF CONFORMITY**

Hereby, we declare that this Smart kit is in compliance with the essential requirements and other relevant provisions of Directive 2014/53/EU. A copy of the full DoC is attached.  
(European Union products only)

# **1** SPECIFICATION

Model: EU-OSK105,US-OSK105, EU-OSK106,  
US-OSK106,EU-OSK109, US-OSK109

Antenna Type: Printed PCB Antenna

Frequency Band: 2400-2483.5MHz

Operation Temperature:0°C~45°C/32°F~113°F

Operation Humidity: 10%~85%

Power Input: DC 5V/500mA

Maximum TX Power: <20dBm

# **2** PRECAUTIONS

- Applicable system: iOS, Android.
  - Please keep you APP up to date with the latest version.
  - Due to special situation may be occurred, we explicitly claims below: Not all of the Android and iOS system are compatible with APP. We will not be responsible for any issue as a result of the incompatibility.
- **Wireless safety strategy**  
Smart kit only support WPA-PSK/WPA2-PSK/WPA3-SAE encryption and none encrytion.WPA-PSK/WPA2-PSK/WPA3-SAE encryption is recommended.
- **Cautions**
  - Due to different network situation, control process may return time-out sometimes. If this situation occurs, the display between board and App may not be the same, please do not feel confused.
  - Smart Phone camera needs to be 5 million pixels or above to make sure scan QR code well.

- Due to different network situation, sometimes, request time-out could happen, thus, it is necessary to do network configuration again.
- The APP system is subject to update without prior notice for product function improvement. The actual network configuration process may be slightly different from the manual, the actual process shall prevail.
- Please Check The Service Website For More information.

### **3** DOWNLOAD AND INSTALL APP

**CAUTION:** The following QR Code is only available for downloading APP. It is totally different with the QR code packed with SMART KIT.



**Android**



**iOS**

- Android Phone users: scan Android QR code or go to google play, search ‘NetHome Plus” app and download it.
- iOS users: scan iOS QR code or go to APP Store, search ‘NetHome Plus” app and download it.

## **4** INSTALL THE SMART KIT(wireless module)

### **WARNING:**

- To avoid electric shock, disconnect the power before installing the smart kit (wireless module).
- For the smart device access, replacement, maintenance operations must be carried out by professional staff.
- The reserved interface is only compatible with smart kit (Wireless module) provided by the manufacturer.

**Note:** Illustrations in this manual are for explanatory purposes. The actual shape of your indoor unit may be slightly different. The actual shape shall prevail.

1) Remove the protective cap of the smart kit.

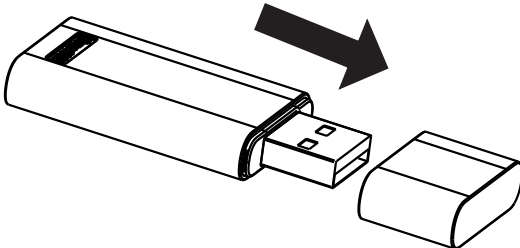

2) Open the front panel and insert the smart kit into the reserved interface (For model A).

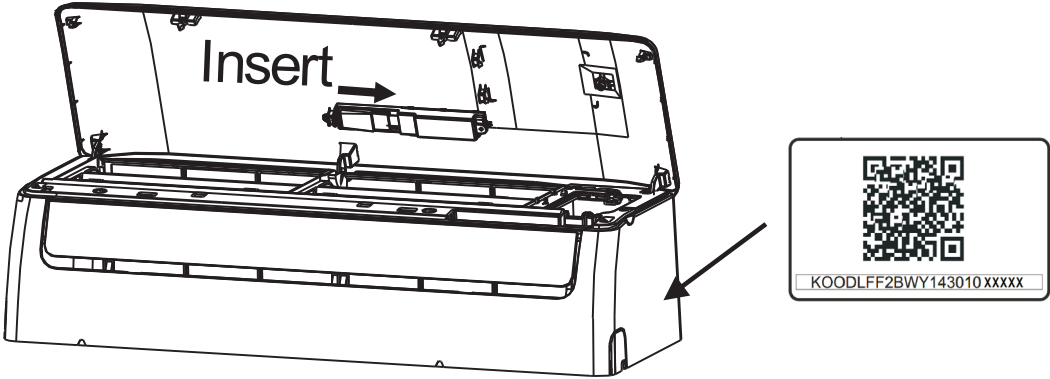

Model A

Open the front panel, unscrew the display cover and remove it, then insert the smart kit into the reserved interface(For model B). Reinstall the display cover.

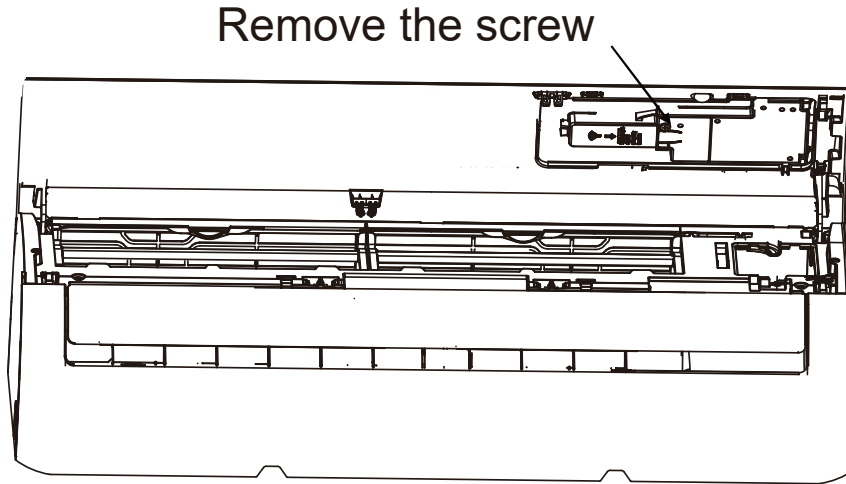

Model B

- 3) Attach the QR code packed with SMART KIT to the side panel of the machine or other convenient location, ensure it is convenience to be scanned by the mobile phone.

**Kindly reminder:** It is better to reserve the other two QR Code in a safe place or take a picture and save it in your own phone.

## 5 USER REGISTRATION

- Please ensure your mobile device is connected to Wireless router. Also, the Wireless router has already connected to Internet before doing user registration and network configuration.
- It is better to log in your email box and active your registration account by clicking link in case you forget the password. You can log in with the third party accounts.

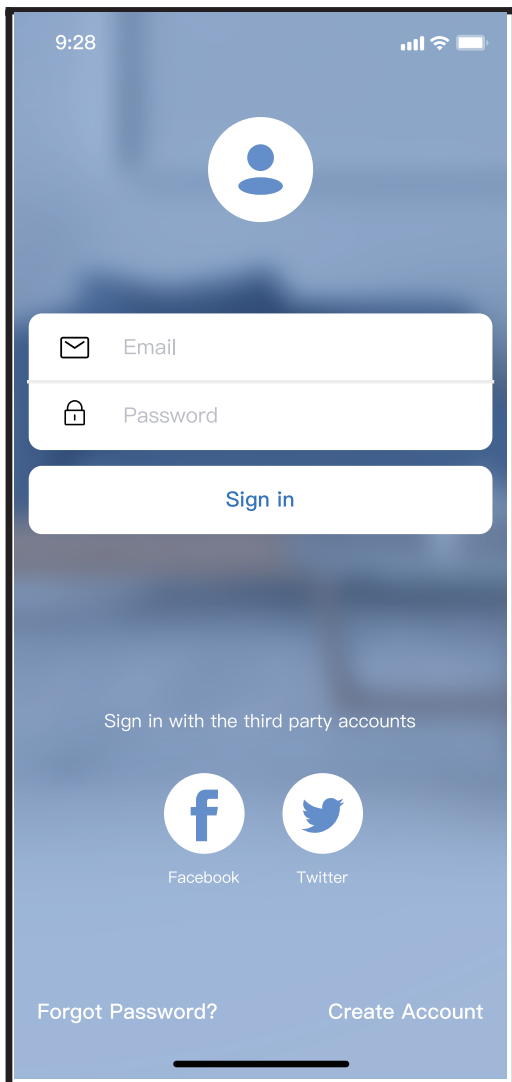

Android

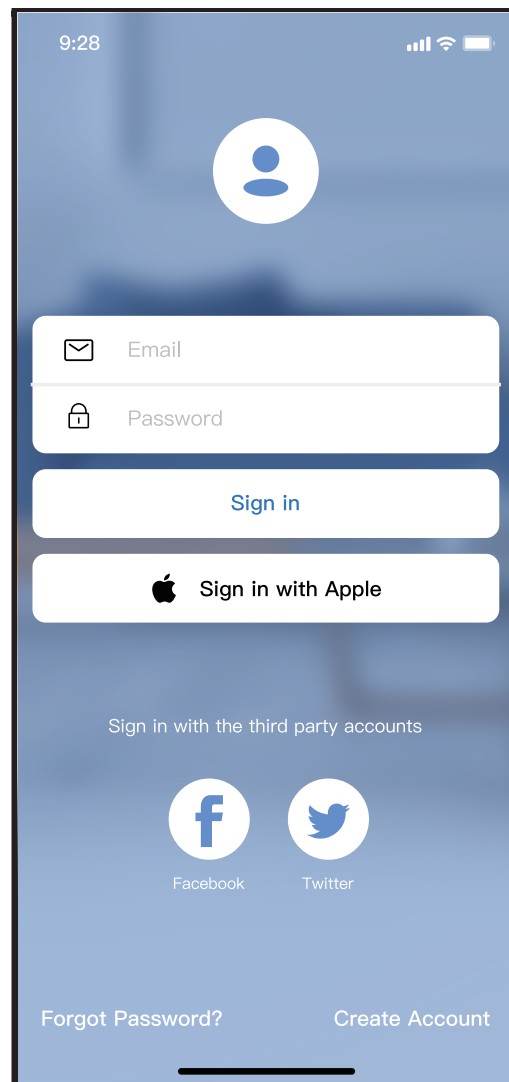

iOS

① Click "Create Account "

9:41

Create Account

Enter your Email address

Password

Confirm Password

Password need 6-20 characters,must contain letters and numbers.

Register

I have read and agree to [the terms and privacy](#)

② Enter your email address and password, and then click "Register"

## **6** NETWORK CONFIGURATION

### **Cautions**

- It is necessary to forget any other around network and make sure the Android or iOS device just connect to the Wireless network you want to configure.
- Make sure the Android or iOS device Wireless function works well and can be connected back to your original Wireless network automatically.

### **Kindly reminder:**

User must finish all the steps in 8 minutes after powering on air conditioner, otherwise you need to power on it again.

### **■ Using Android or iOS device to do network configuration**

- Make sure your mobile device has already been connected to the Wireless network which you want to use. Also, you need to forget other irrelevant Wireless network in case it influences your configuration process.
- Disconnect the power supply of AC.
- Connect the power supply of AC, and continuously press the “LED DISPLAY” or “DO NOT DISTURB” button seven times in 10 seconds.
- When the AC displays “AP”, it means that the AC Wireless has already entered into “AP” mode.

### **Note:**

There are two ways to finish the network configuration:

- Network configuration by Bluetooth scan
- Network configuration by select appliance type

# Network configuration by Bluetooth scan

Note: Make sure the bluetooth of your mobile device is working.

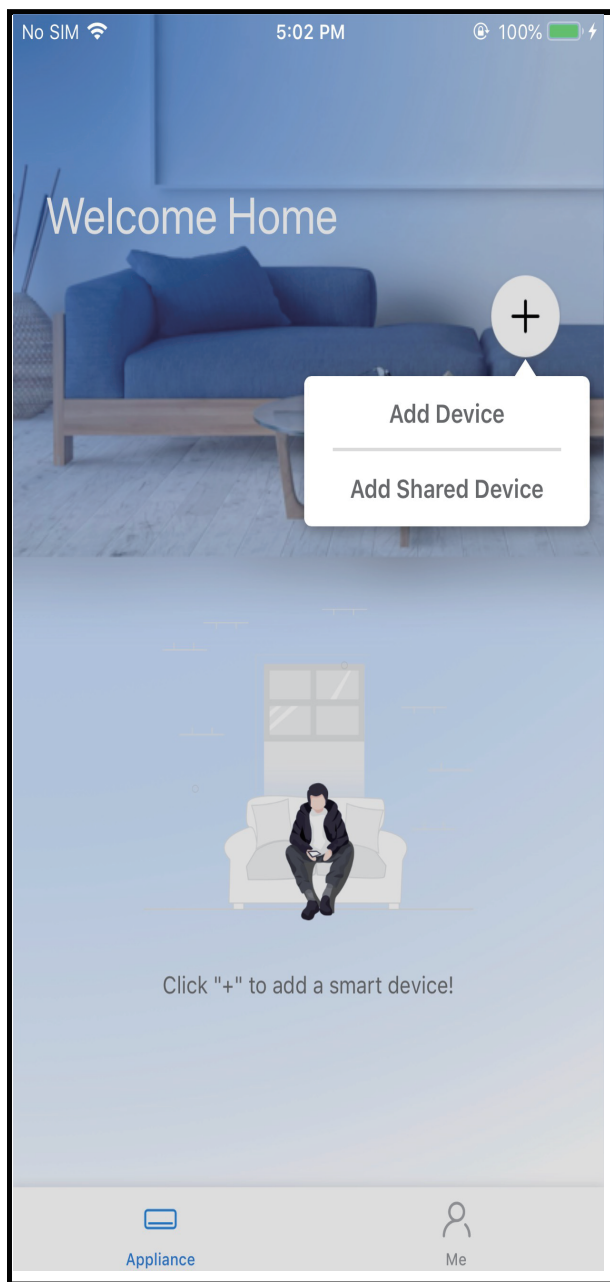

① Press “ + Add Device ”

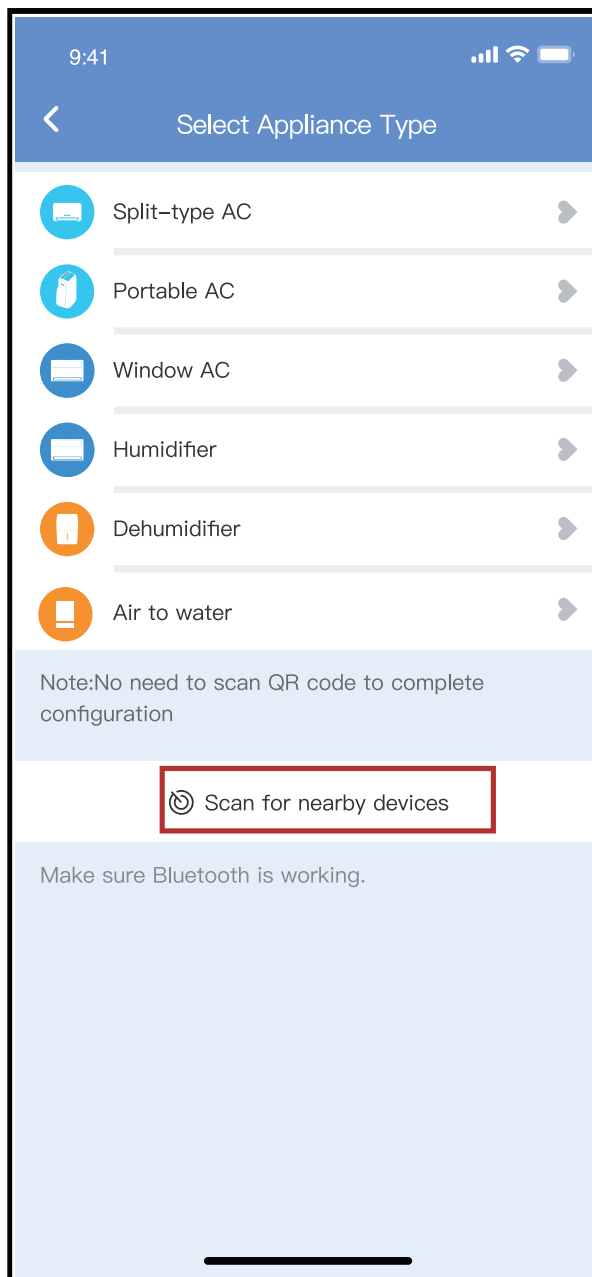

② Press “Scan for nearby devices”

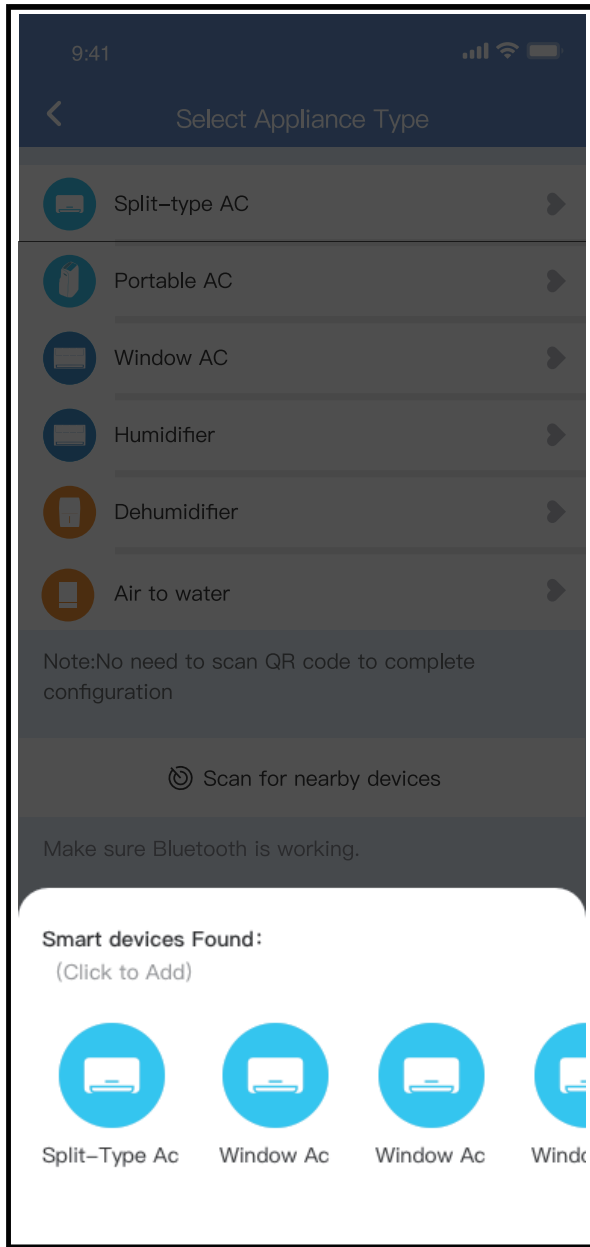

③ Wait smart devices to find, then click to add it

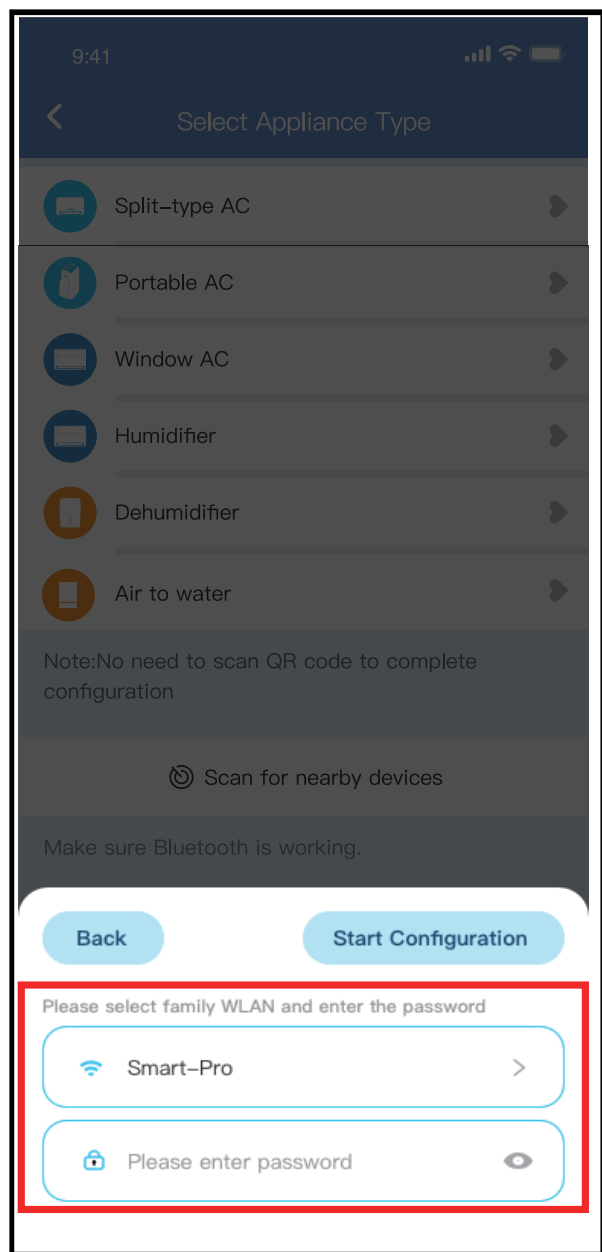

④ Select home Wireless, enter the password

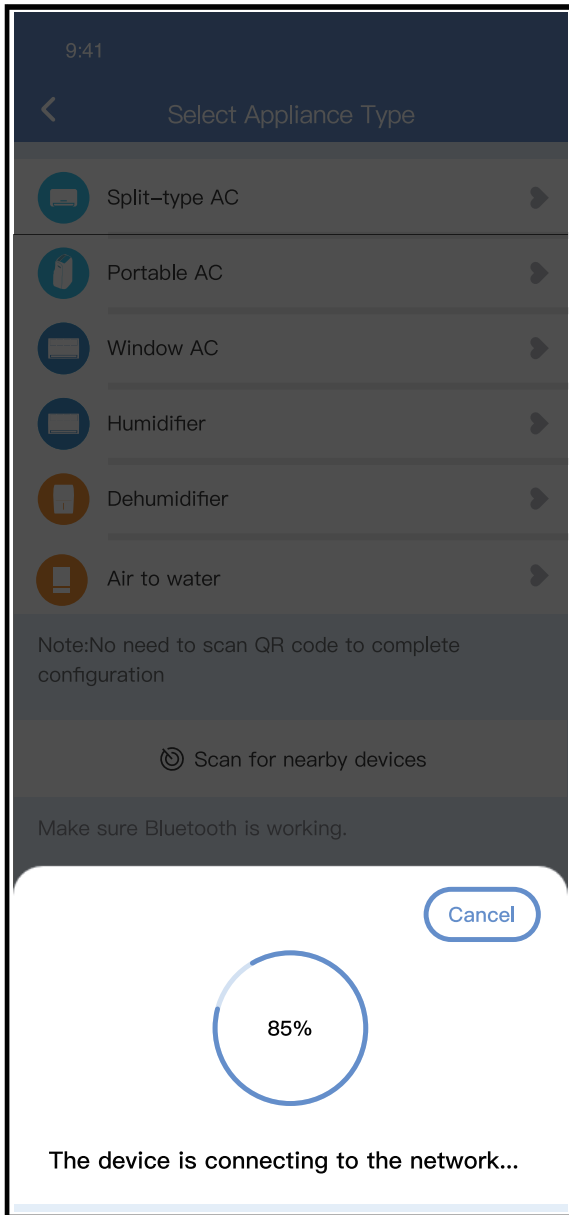

⑤ Wait connecting to the network

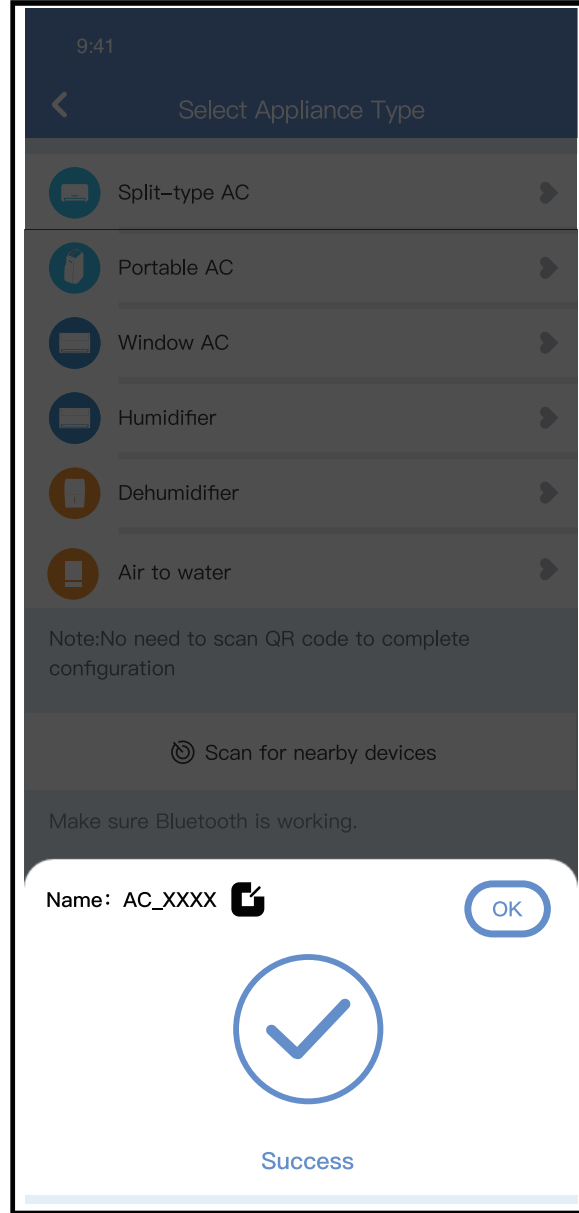

⑥ Configuration Success, you can modify the default name.

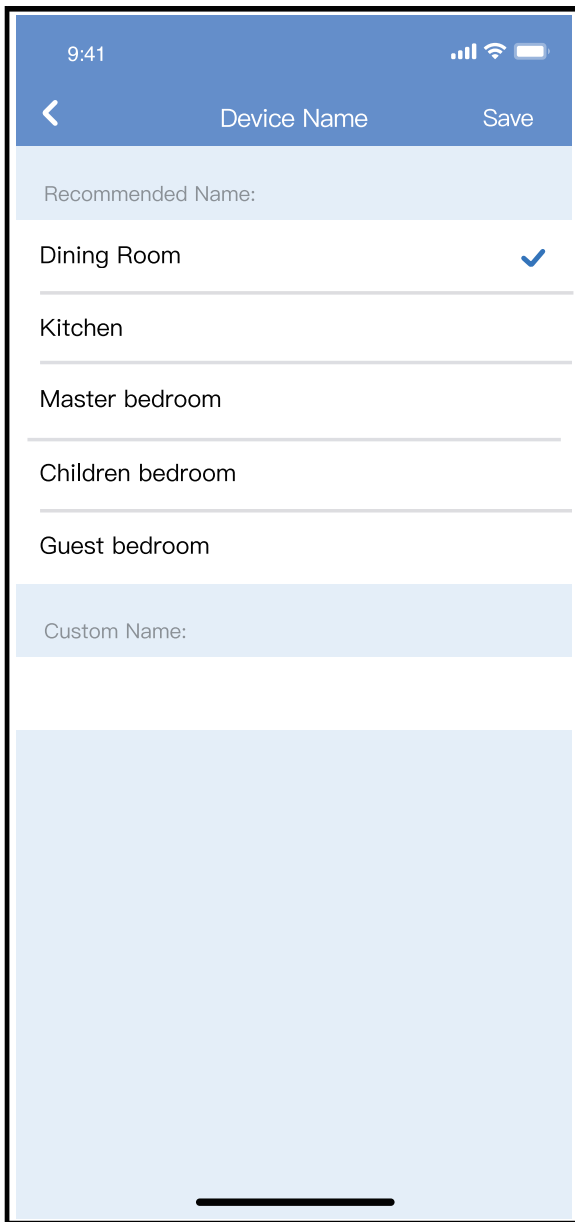

⑦ You can choose an existing name or customize a new name.

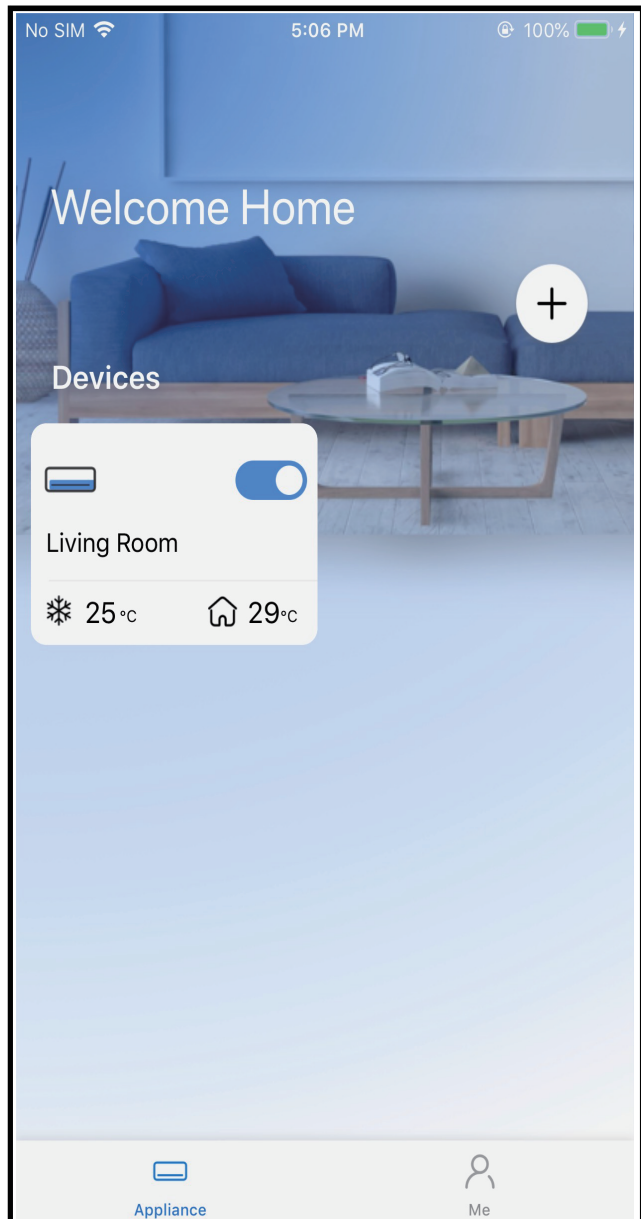

⑧ Bluetooth network configuration is successful, now you can see the device in the list.

## Network configuration by select appliance type :

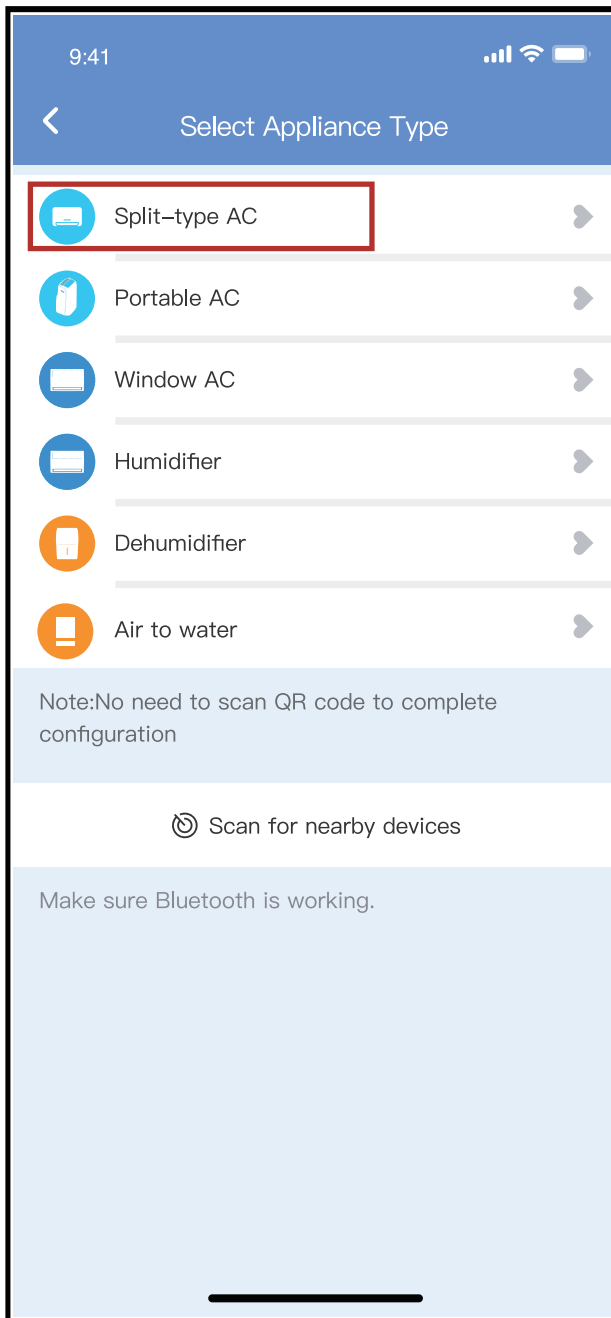

- ① If the bluetooth network configuration is failure, please select the appliance type.

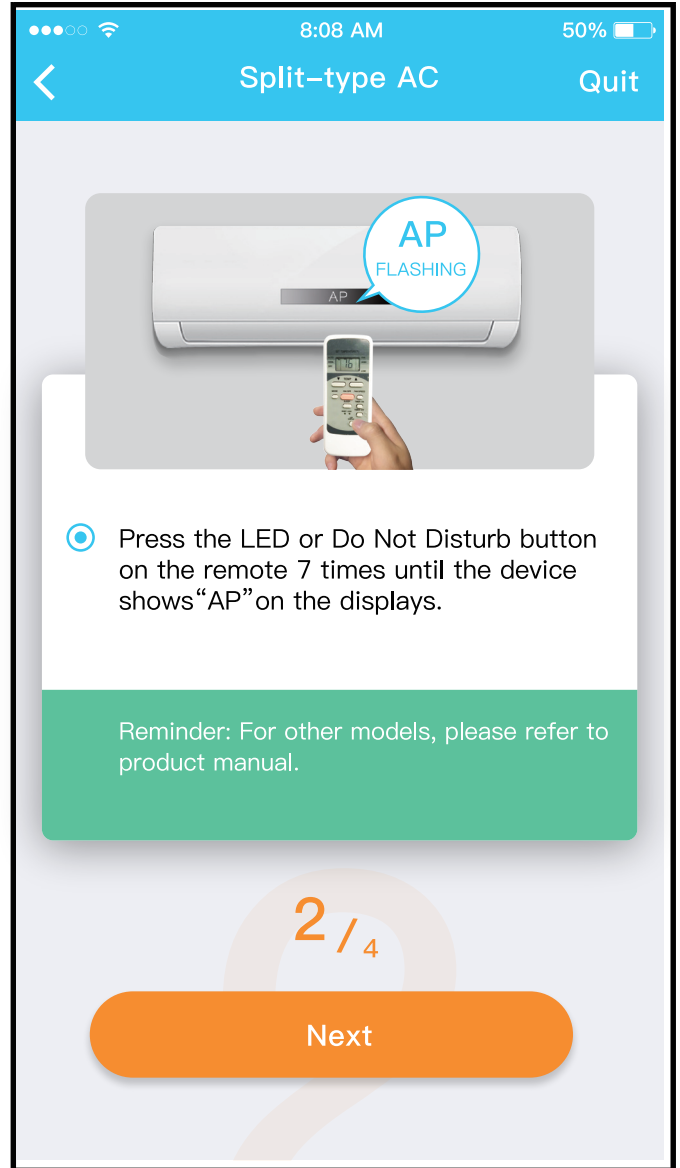
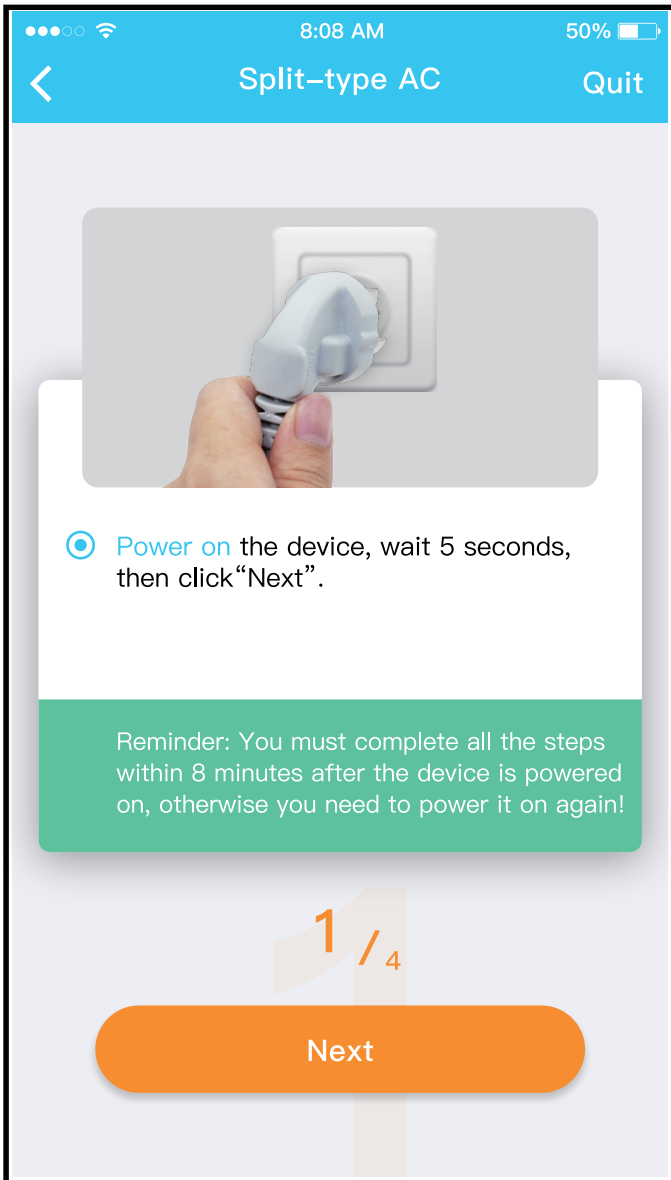

② please follow the above steps to enter "AP" mode.

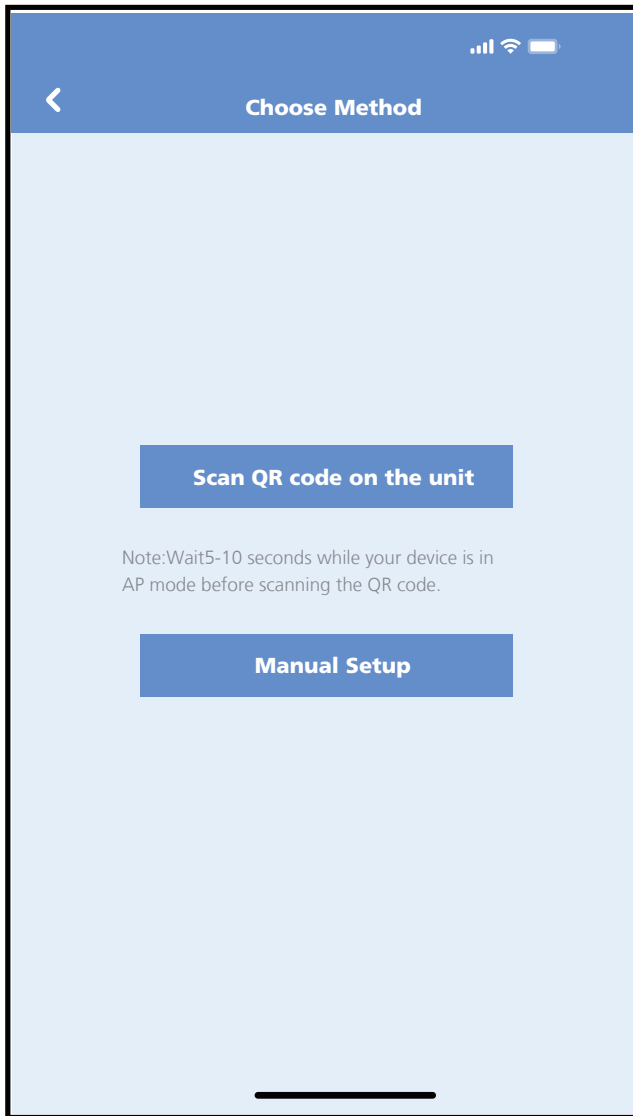

③ Choose the network configuration method.

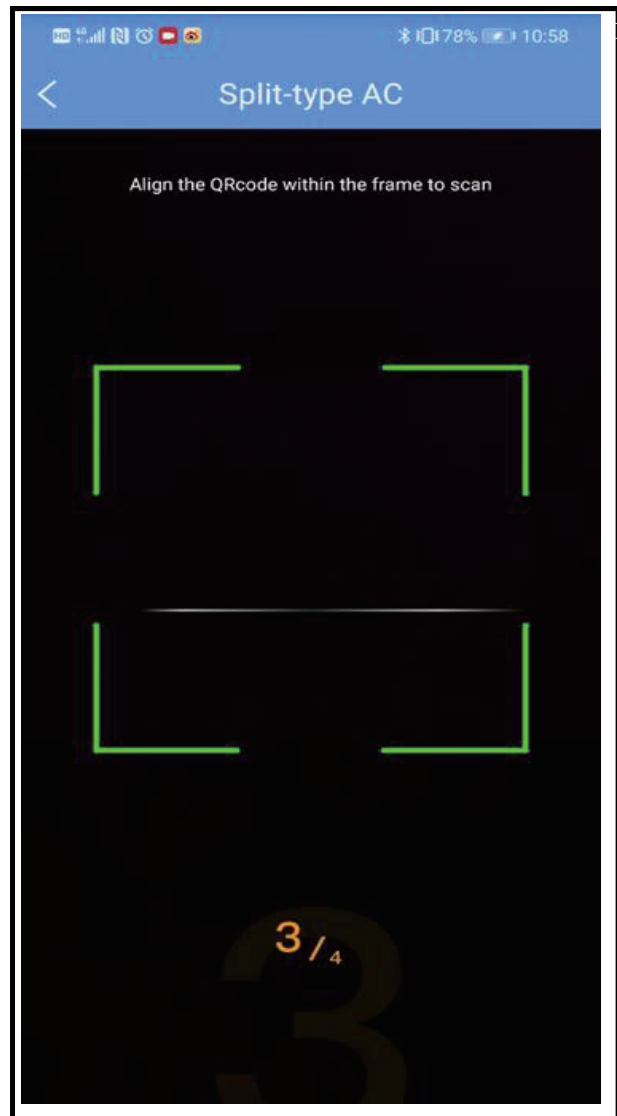

④ Choose the "Scan the QR code" method.

**NOTE: Steps ③ and ④ are applicable to Android system only. iOS system does not need these two steps.**

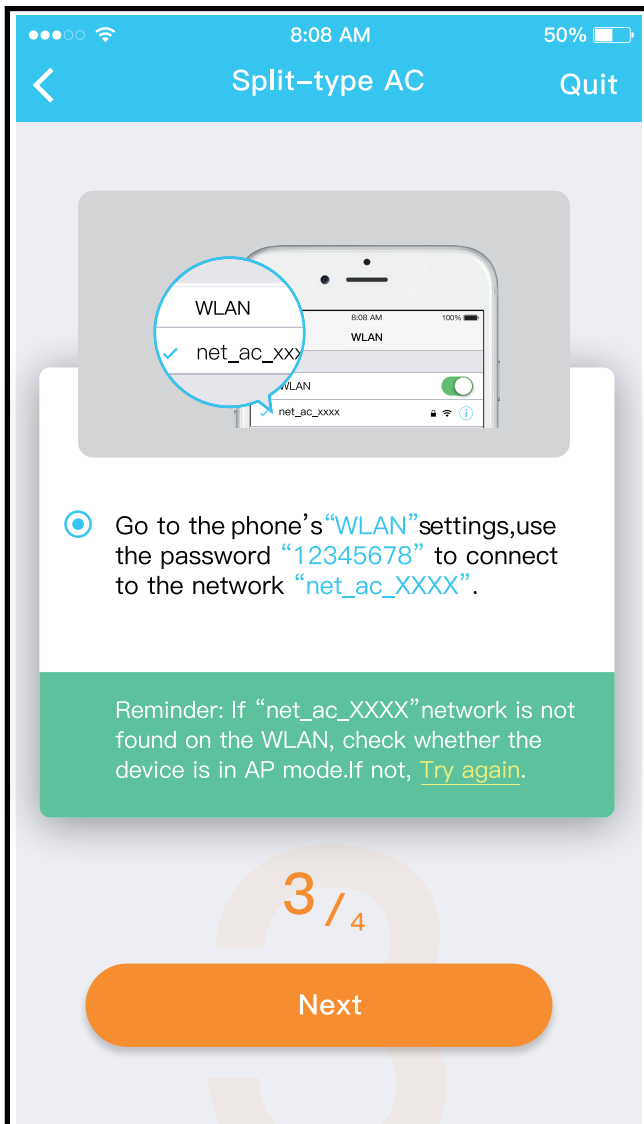

⑤ When choose the “Manual Setup” method(Android). Connect to the wireless network(iOS)

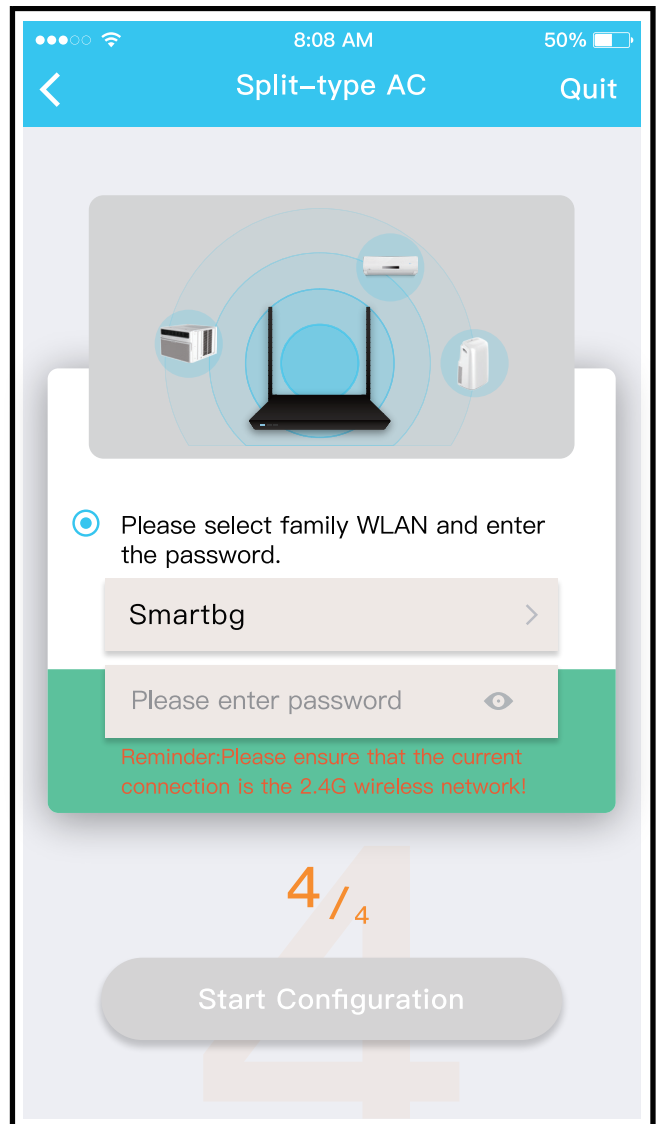

⑥ Please enter password

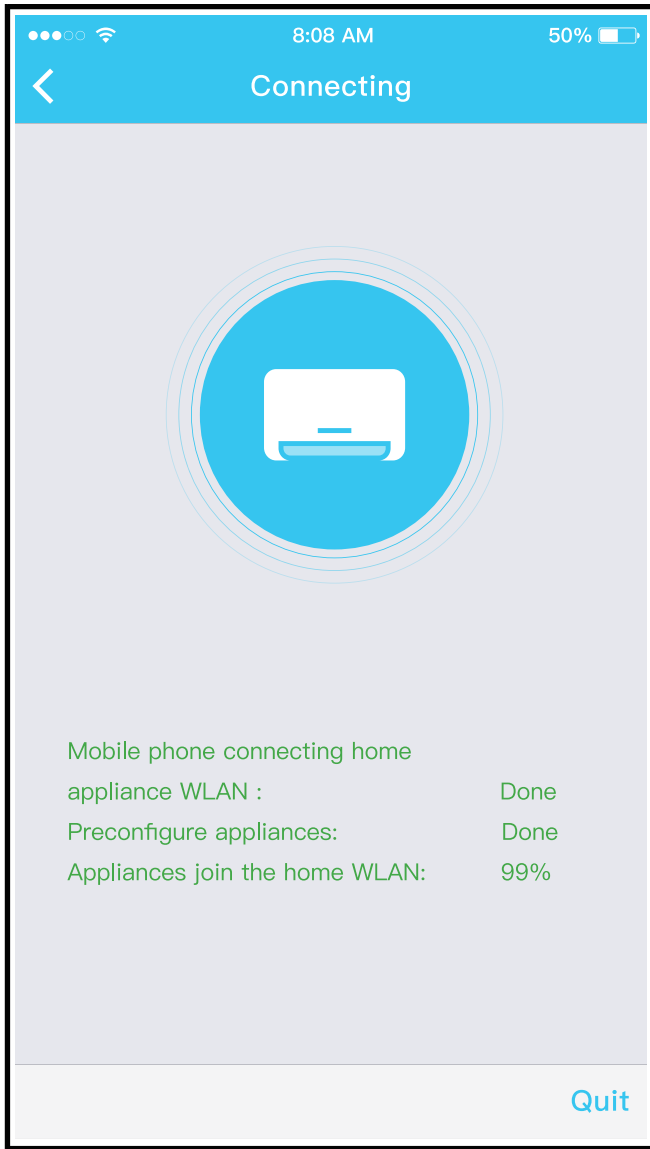

⑦ Network configuration is successful

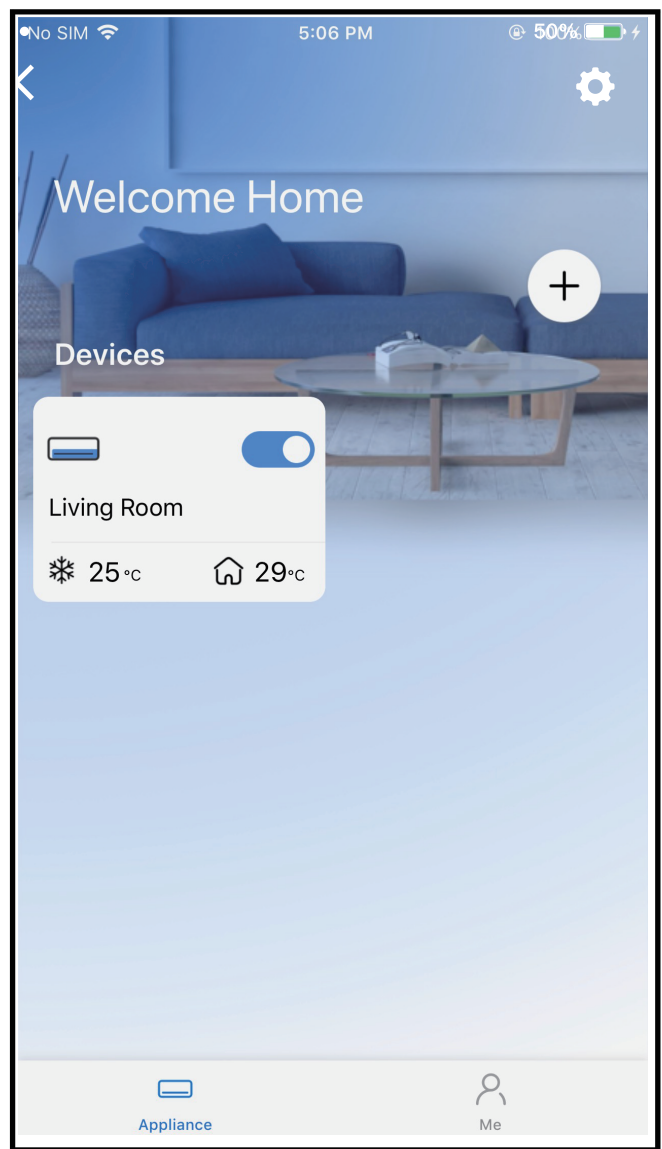

⑧ Configuration Success, you can see the device in the list.

**NOTE:**

- When finishing network configuration, APP will display success cue words on the screen.
- Due to different internet environment, it is possible that the device status still display “offline” . If this situation occurs, it is necessary to pull and refresh the device list on the APP and make sure the device status become “online” . Alternatively, user can turn off the AC power and turn on it again, the device status will become “online” after few minutes.

# 7 HOW TO USE APP

Please ensure both your mobile device and air conditioner are connected to the Internet before using app to control the air conditioner via internet, please follow the next steps:

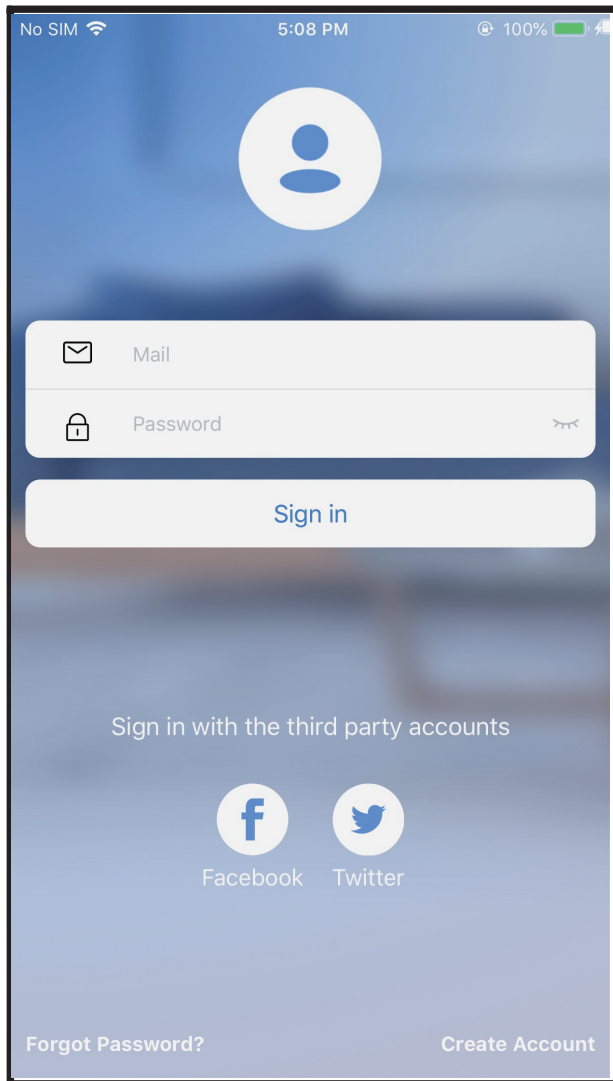

① Click " Sign in "

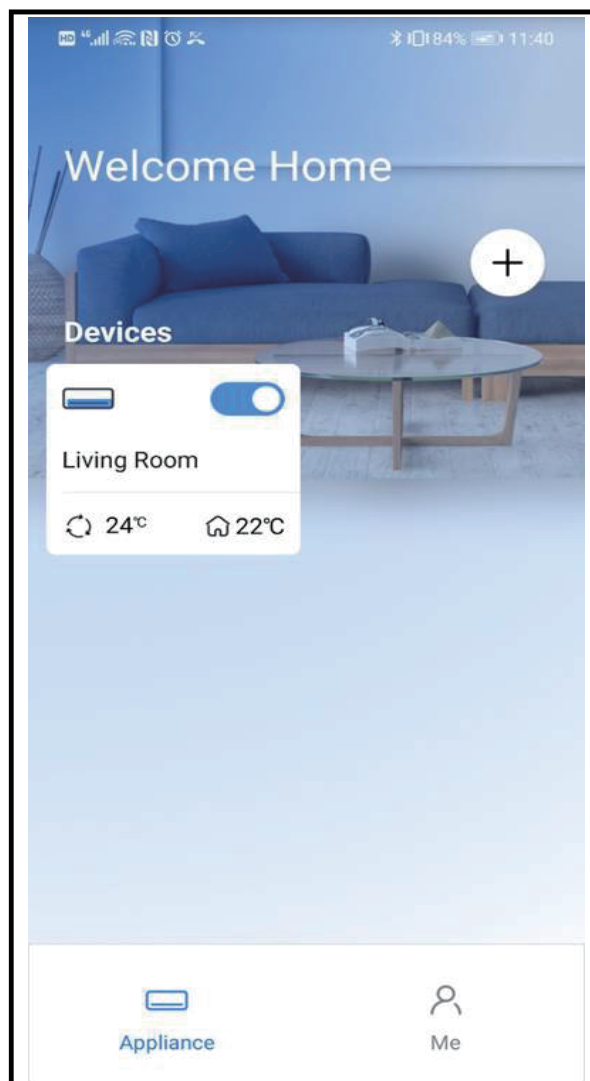

② Choose the air conditioner.

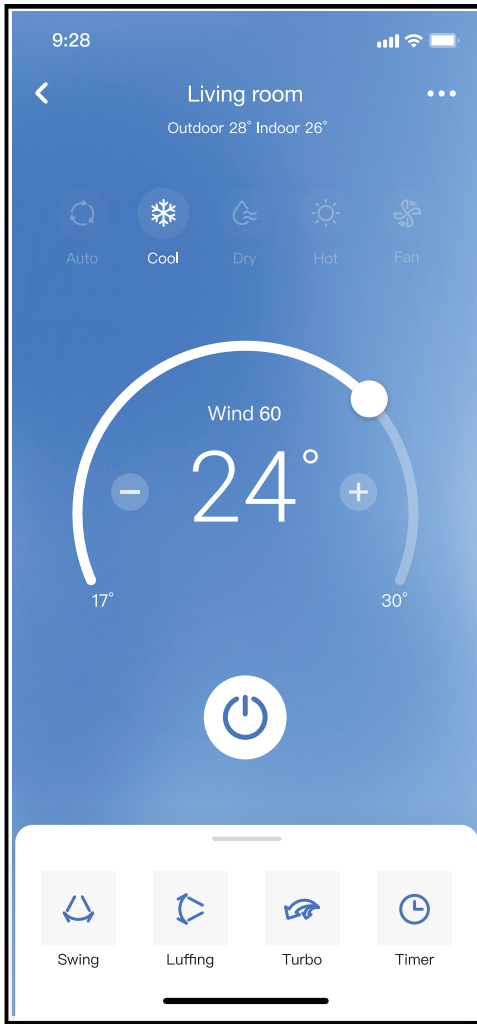

- ③ Thus, user can control air conditioners on/off status, operation mode, temperature, fan speed and so on.

**NOTE:**

Not all the function of the APP is available on air conditioner. For example: ECO, Turbo, Swing function, please check the user manual to find more information.

# 8 SPECIAL FUNCTIONS

## ■ Schedule

Weekly, user can make an appointment to turn on or off AC on specific time. User also can choose circulation to keep the AC under schedule control every week.

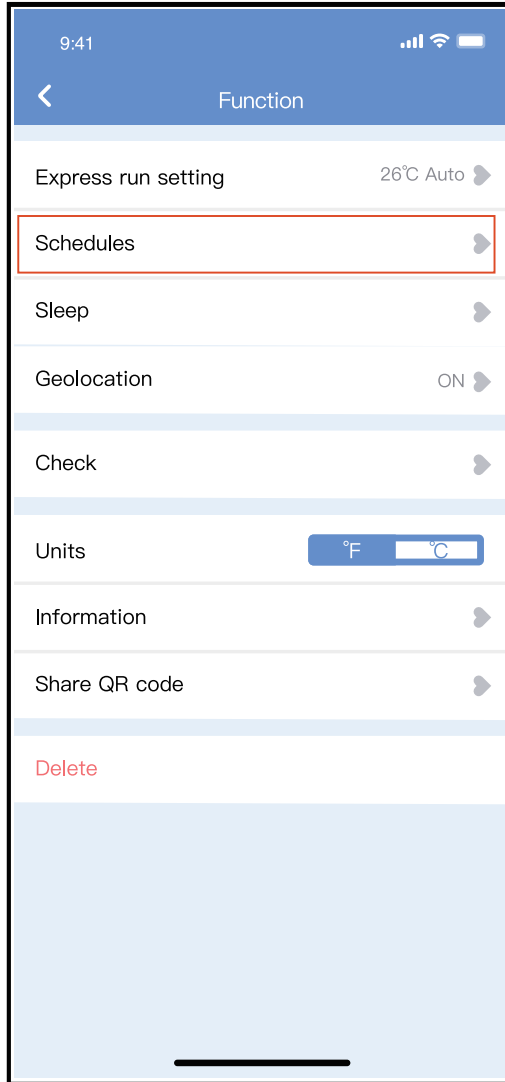

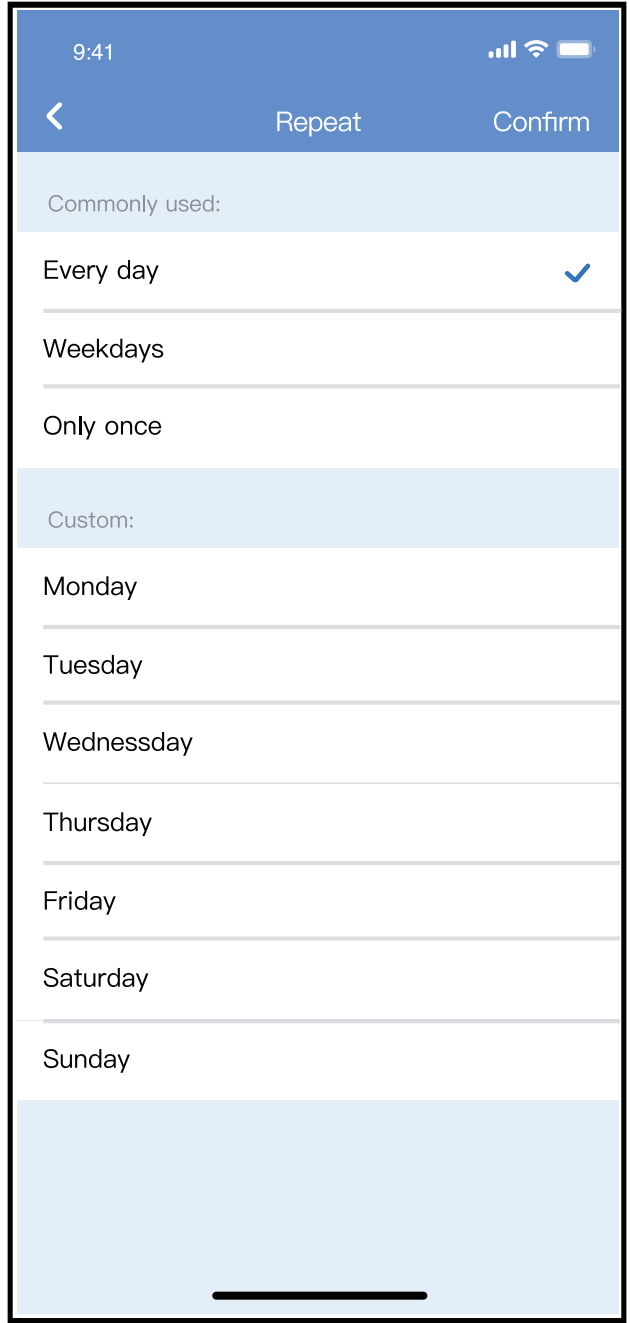
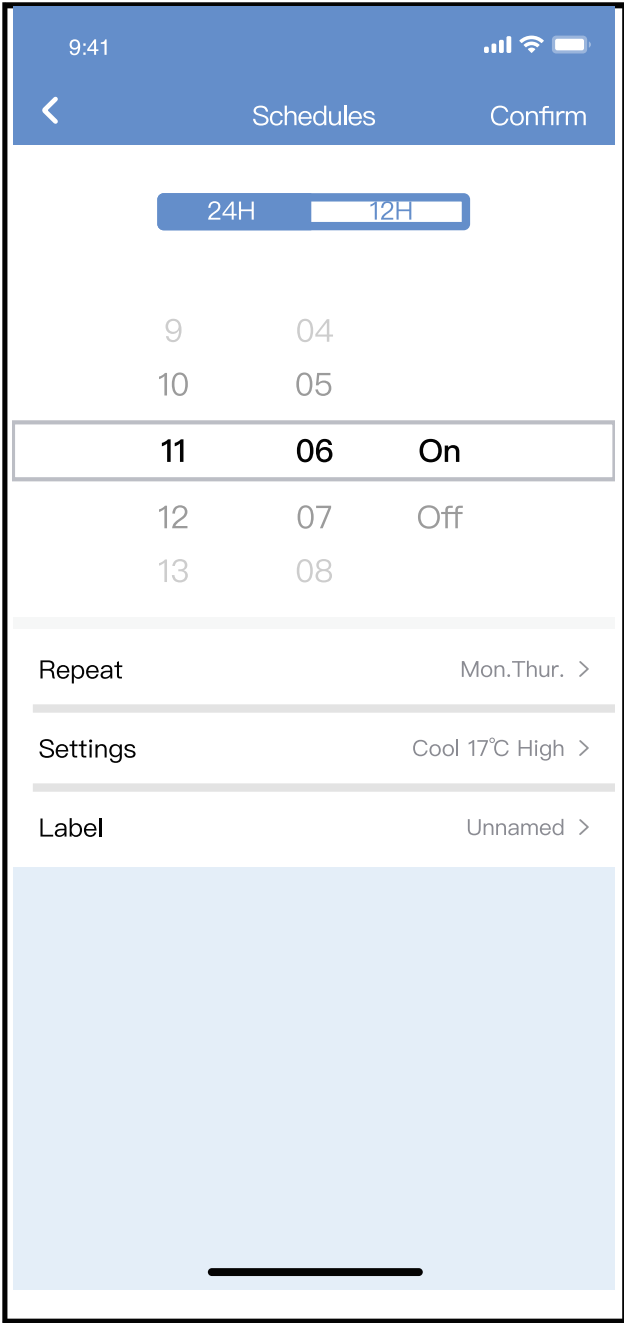

# ■ Sleep

User can customize their own comfortable sleep by setting target temperature.

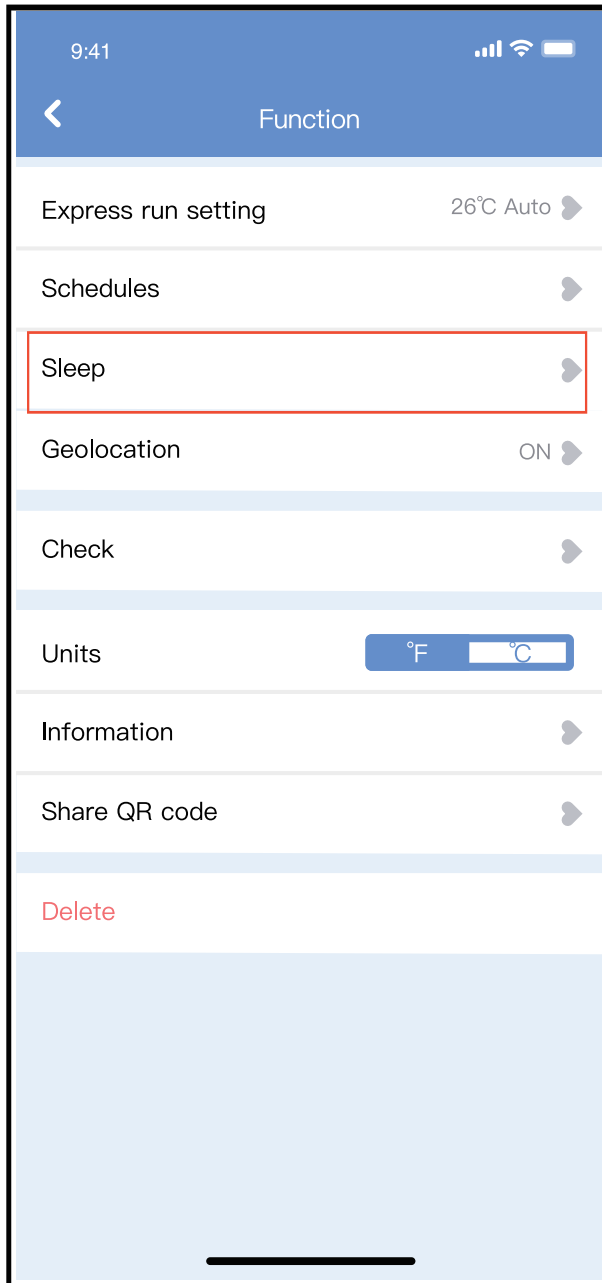

## ■ Check

User can simply check the AC running status with this function. When finishing this procedure, it can display the normal items, abnormal items, and detail information.

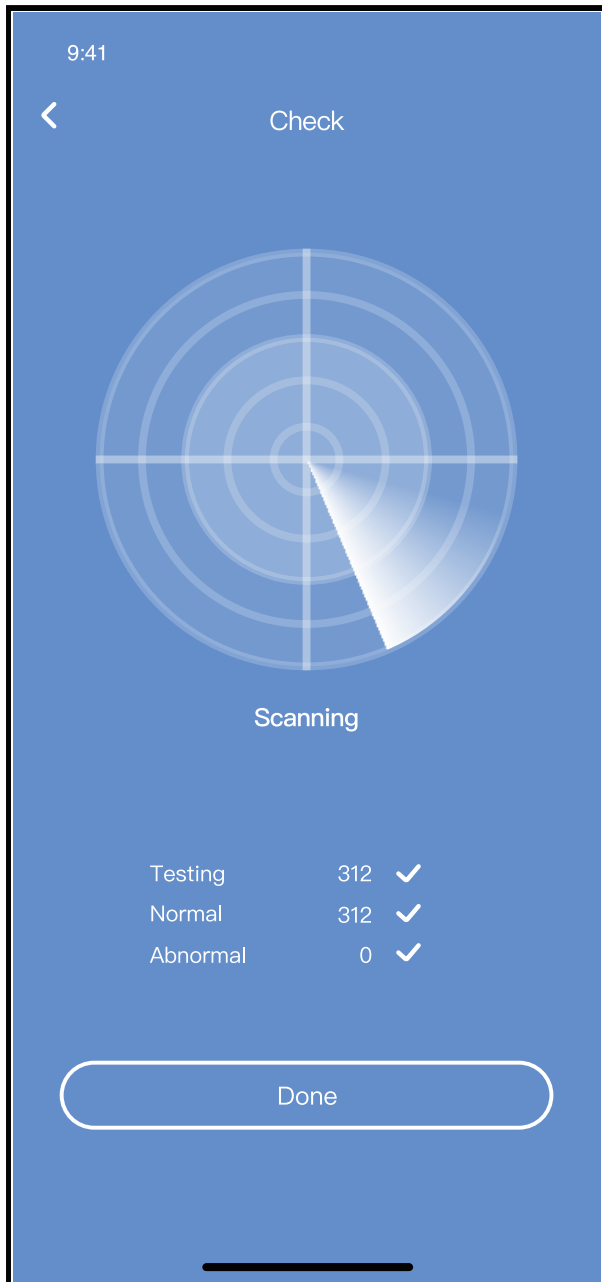

## ■ Share Device

The air conditioner can be controlled by multi-users at the same time by Share Device function.

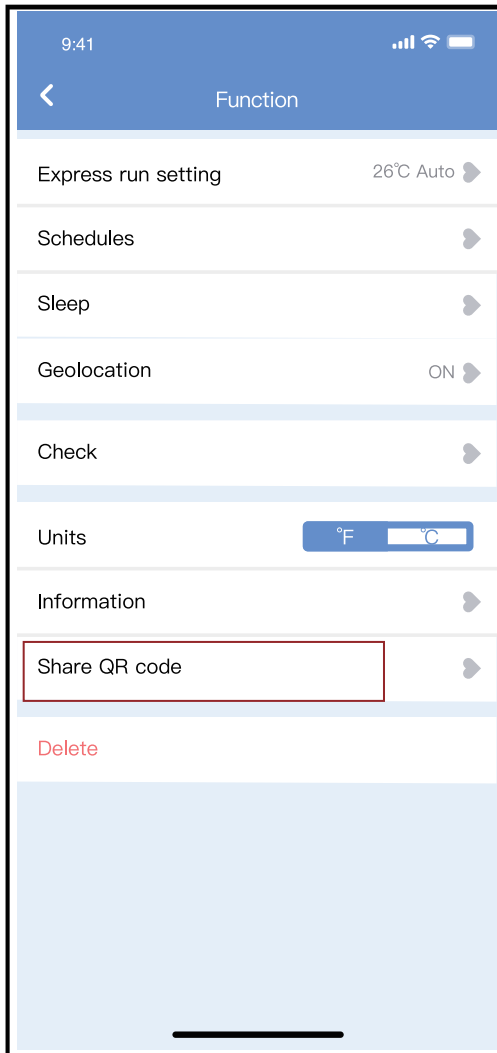

① Click “Shared QR code”    ② QR code display.

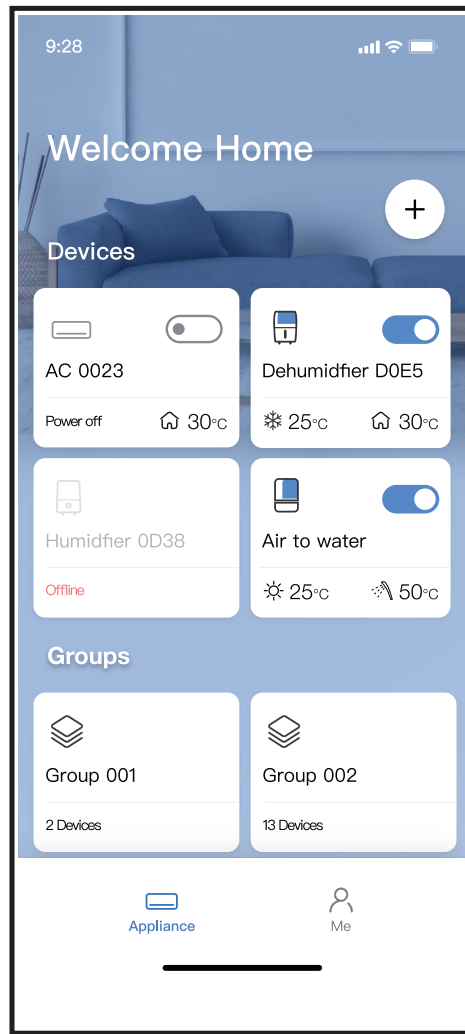
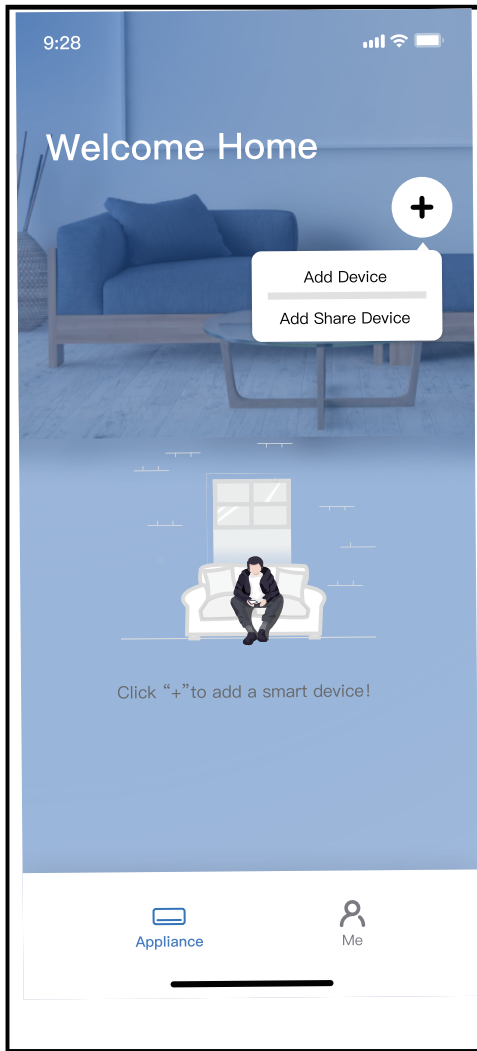

③ The other users must log in "Nethome Plus" app first, then click "Add Share Device" on their own mobile, then ask them to scan the QR code.

④ Now the others can add the shared device.

## **CAUTIONS:**

**Wireless module models: US-OSK105, EU-OSK105**

FCC ID:2AS2HMZNA21

IC:24951-MZNA21

**Wireless module models: US-OSK106, EU-OSK106**

FCC ID:2AS2HMZNA22

IC:24951-MZNA22

**Wireless module models: US-OSK109,EU-OSK109**

FCC ID: 2AS2HMZNA23

IC: 24951-MZNA23

This device complies with Part 15 of the FCC Rules and it contains licence-exempt transmitter(s)/receiver(s) that comply with Innovation, Science and Economic Development Canada's licence-exempt RSS(s).

Operation is subject to the following two conditions:

- (1) This device may not cause harmful interference; and
- (2) This device must accept any interference, including interference that may cause undesired operation of the device.

Only operate the device in accordance with the instructions supplied.

Changes or modifications to this unit not expressly approved by the party responsible for compliance could void the user's authority to operate the equipment.

This device complies with FCC radiation exposure limits set forth for an uncontrolled environment. In order to avoid the possibility of exceeding the FCC radio frequency exposure limits, human proximity to the antenna shall not be less than 20cm (8 inches) during normal operation.

### **In Canada:**

CAN ICES-3(B)/NMB-3(B)

Le présent appareil est conforme aux CNR Innovation, Sciences et Développement économique Canada applicables aux appareils radio exempts de licence.

L'exploitation est autorisée aux deux conditions suivantes:

(1) il ne doit pas produire de brouillage et (2) l'utilisateur du dispositif doit être prêt à accepter tout brouillage radioélectrique reçu, même si ce brouillage est susceptible de compromettre le fonctionnement du dispositif.

Cet émetteur ne doit pas être Co-placé ou ne fonctionnant en même temps qu'aucune autre antenne ou émetteur.

Cet équipement devrait être installé et actionné avec une distance minimum de 20 millimètres entre le radiateur et votre corps.

NOTE: This equipment has been tested and found to comply with the limits for a Class B digital device, pursuant to part 15 of the FCC Rules. These limits are designed to provide reasonable protection against harmful interference in a residential installation. This equipment generates, uses and can radiate radio frequency energy and, if not installed and used in accordance with the instructions, may cause harmful interference to radio communications. However, there is no guarantee that interference will not occur in a particular installation. If this equipment does cause harmful interference to radio or television reception, which can be determined by turning the equipment off and on, the user is encouraged to try to correct the interference by one or more of the following measures:

- Reorient or relocate the receiving antenna.
- Increase the separation between the equipment and receiver.
- Connect the equipment into an outlet on a circuit different from that to which the receiver is connected.
- Consult the dealer or an experienced radio/TV technician for help.

---

Due to ongoing product improvements, specifications and dimensions are subject to change and correction without notice or incurring obligations. Determining the application and suitability for use of any product is the responsibility of the installer. Additionally, the installer is responsible for verifying dimensional data on the actual product prior to beginning any installation preparations.

Incentive and rebate programs have precise requirements as to product performance and certification. All products meet applicable regulations in effect on date of manufacture; however, certifications are not necessarily granted for the life of a product. Therefore, it is the responsibility of the applicant to determine whether a specific model qualifies for these incentive/rebate programs.



1900 Wellworth Ave., Jackson, MI 49203 • Ph. 517-787-2100 • [www.heatcontroller.com](http://www.heatcontroller.com)