Comfort-Cire®

Century®

SMART KIT USER MANUAL

Single-Multi Zone Mini-Splits

Model

VMH06, 09, 12, 18, 24 SV Series

IMPORTANT NOTE:

Read the manual carefully before installing or connecting your Smart kit(Wireless module). Make sure to save this manual for future reference.

CONTENTS

① SPECIFICATION.....	1
② PRECAUTIONS	1
③ DOWNLOAD AND INSTALL APP.....	2
④ INSTALL THE SMART KIT.....	3
⑤ USER REGISTRATION	4
⑥ NETWORK CONFIGURATION.....	6
⑦ HOW TO USE APP.....	17
⑧ SPECIAL FUNCTIONS.....	19

1 SPECIFICATION

Model: EU-OSK105,US-OSK105

Standard: IEEE 802. 11b/g/n

Antenna Type: Printed PCB Antenna

Frequency Band: 2400-2483.5MHz

Operation Temperature:0°C~45°C/32°F~113°F

Operation Humidity: 10%~85%

Power Input: DC 5V/300mA

Maximum TX Power: <20dBm

2 PRECAUTIONS

- Applicable system: iOS, Android.
 - Please keep your APP up to date with the latest version.
 - Due to special situations that may occurs we explicitly claim below: Not all of the Android and iOS systems are compatible with APP. We will not be responsible for any issue as a result of the incompatibility.
- **Wireless safety strategy**
Smart kit only support WPA-PSK/WPA2-PSK encryption and none encryption .
WPA-PSK/WPA2-PSK encryption is recommended.
- **Cautions**
 - Due to different network situations, control process may return time-out sometimes. If this situation occurs, the display between board and App may not be the same. Smart Phone camera needs to be 5 million pixels or above to make sure it scans QR code well.

- Due to different network situations, sometimes, request time-out could happen, thus, it is necessary to do network configuration again.
- The APP system is subject to updates without prior notice for product function improvement. The actual network configuration process may be slightly different from the manual, the actual process shall prevail.
- Please Check The Service Website For More information.

3 DOWNLOAD AND INSTALL APP

CAUTION: The following QR Code is only available for downloading APP. It is totally different with the QR code packed with SMART KIT.



Android



iOS

- Android Phone users: scan Android QR code or go to google play, search ‘NetHome Plus” app and download it.
- iOS users: scan iOS QR code or go to APP Store, search ‘NetHome Plus” app and download it.

4 INSTALL THE SMART KIT(wireless module)

- ① Remove the protective cap of the smart kit (wireless module)
- ② Open the front panel and insert the smart kit (wireless module) into the reserved interface.
- ③ Attach the QR code packed with Smart kit (wireless module) to the side panel of the machine, ensure it is convenient to be scanned by the mobile phone. Alternatively, user can take picture of the QR Code and save it into their own phones.

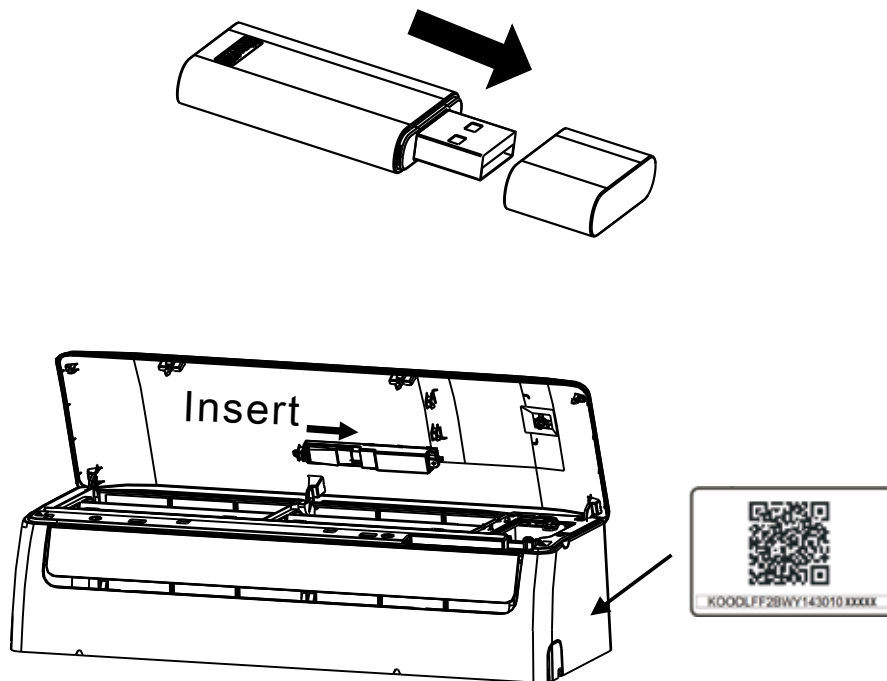

WARNING :This interface is only compatible with SMART KIT(wireless module) provided by the manufacturer.

5 USER REGISTRATION

- Please ensure your mobile device is connected to Wireless router. Also, the Wireless router has already connected to Internet before doing user registration and network configuration.

- It is better to log in your email box and activate your registration account by clicking link in case you forget the password. You can log in with the third party accounts

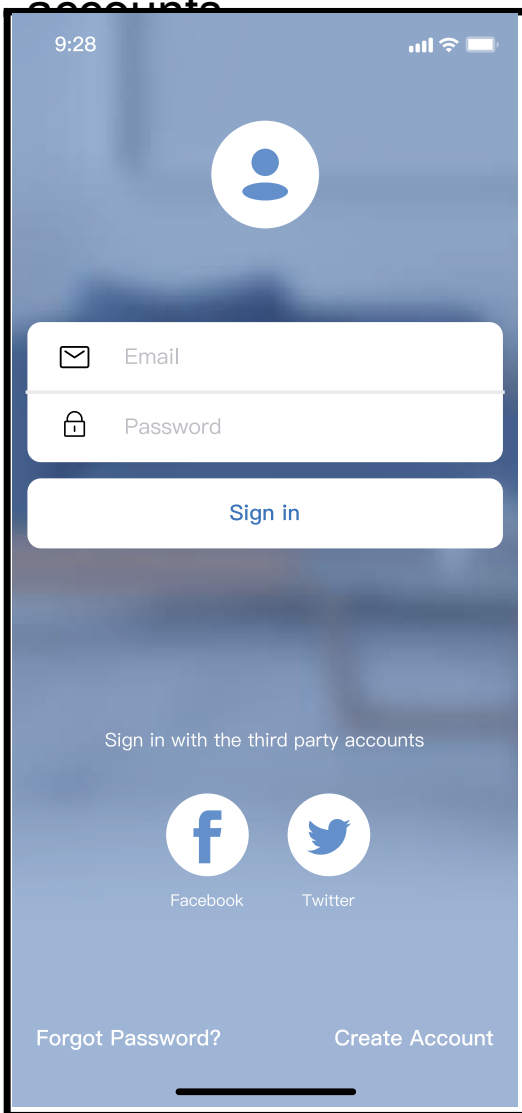

Android

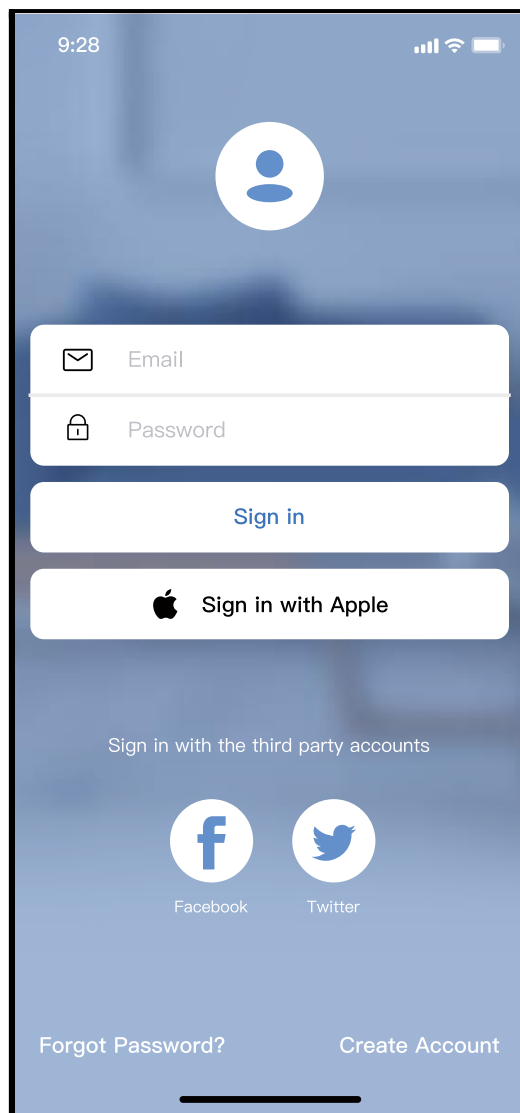

iOS

① Click "Create Account"

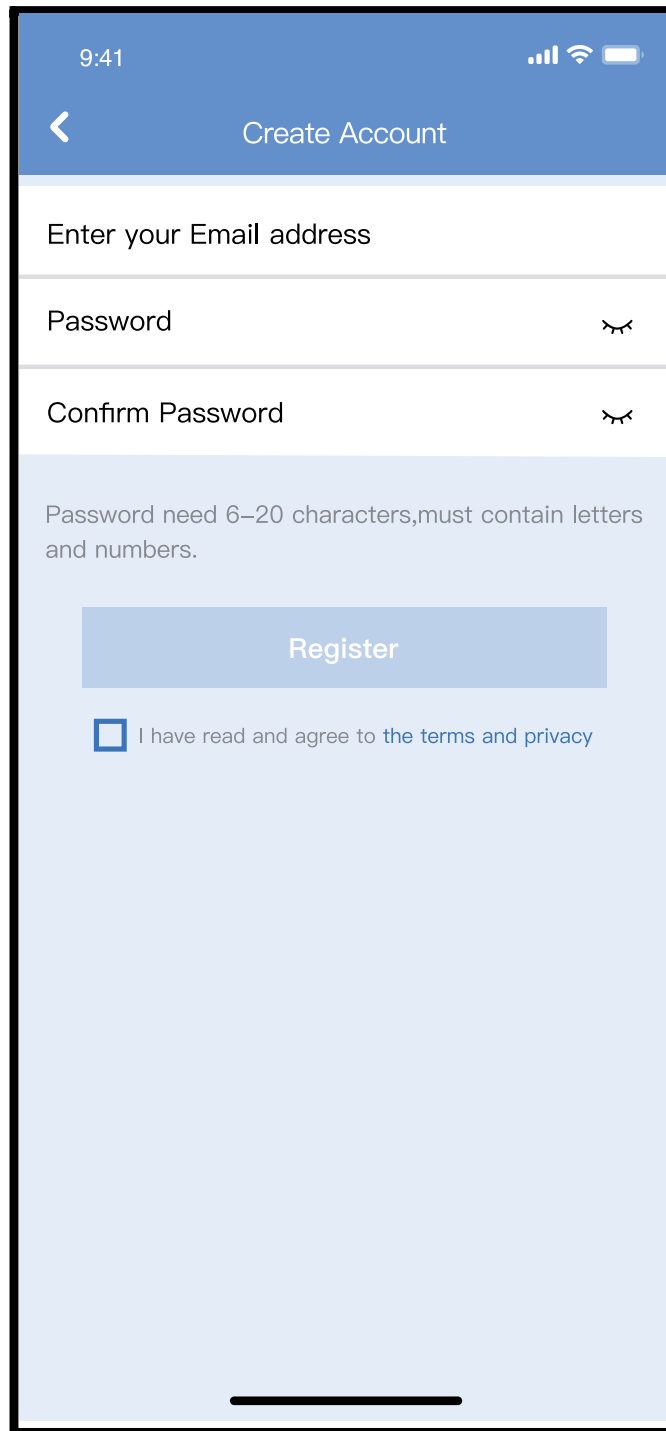

② Enter your email address and password, and then click "Register"

6 NETWORK CONFIGURATION

Cautions

- It is necessary to connect the Android or iOS device just connect to the Wireless network you want to configure.
- Make sure the Android or iOS device Wireless function works well and can be connected back to your original Wireless network automatically.

Reminder:

User must finish all the steps in 8 minutes after powering on air conditioner, otherwise you need to power on it again.

■ Using Android or iOS device to do network configuration

- Make sure your mobile device has already been connected to the Wi-Fi network which you want to use. Disconnect the power supply of AC.
- Connect the power supply of AC, and continuously press the “LED DISPLAY” or “DO NOT DISTURB” button seven times in 10 seconds.
- When the AC displays “AP”, it means that the AC Wi-Fi has already entered into “AP” mode.
-

Note:

There are two ways to finish the network configuration:

- Network configuration by Bluetooth scan
- Network configuration by select appliance type

Network configuration by Bluetooth scan

Note: Make sure the bluetooth of your mobile device is working.

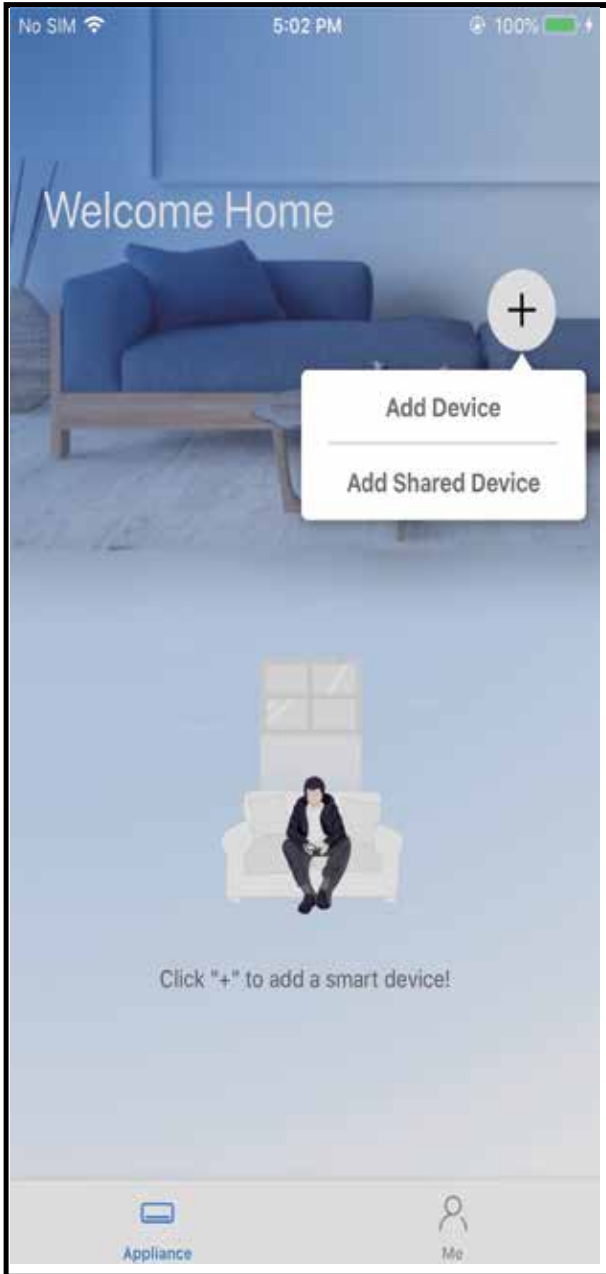

① Press “ + Add Device ”

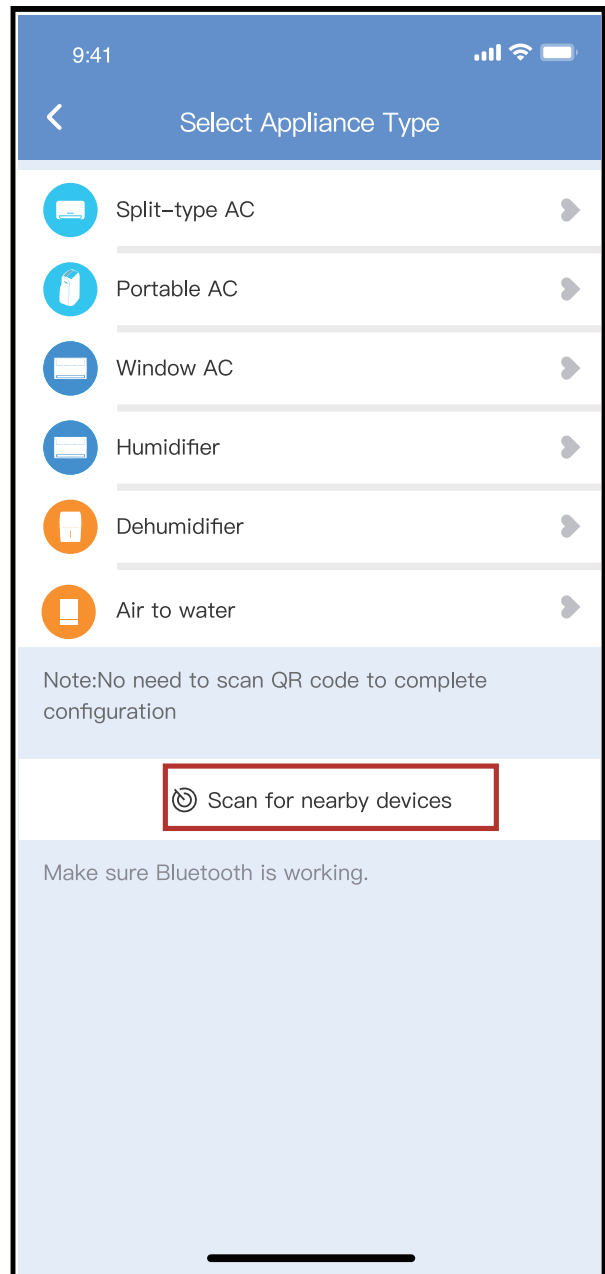

② Press “Scan for nearby devices”

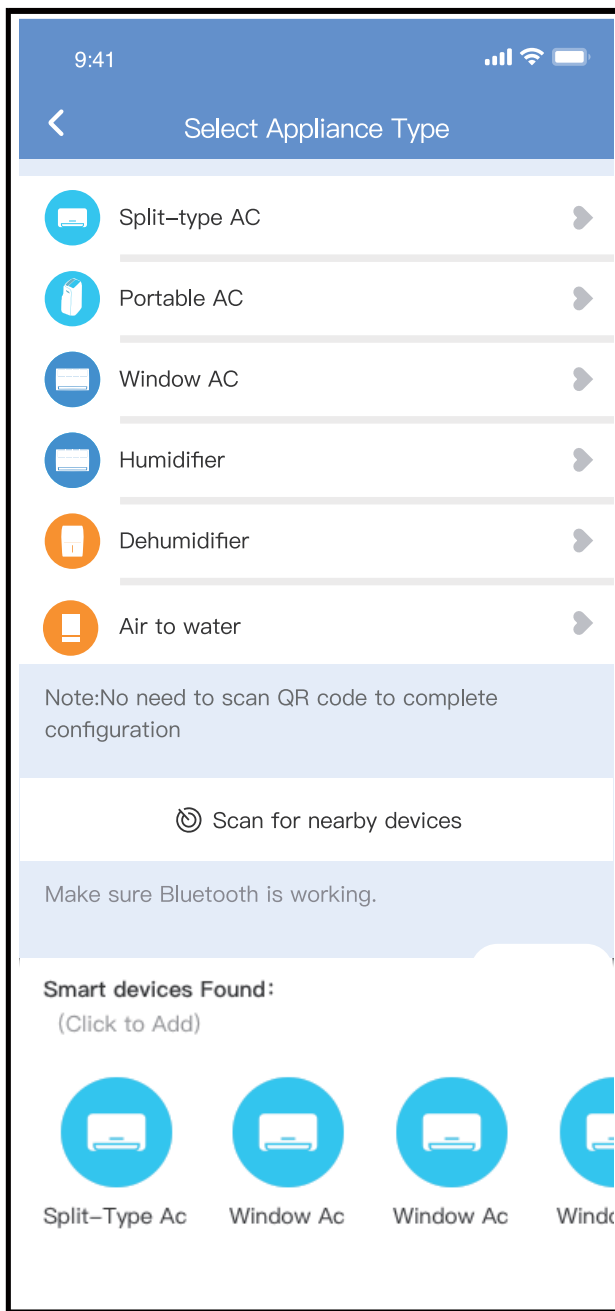

③ Wait smart devices to find, then click to add it

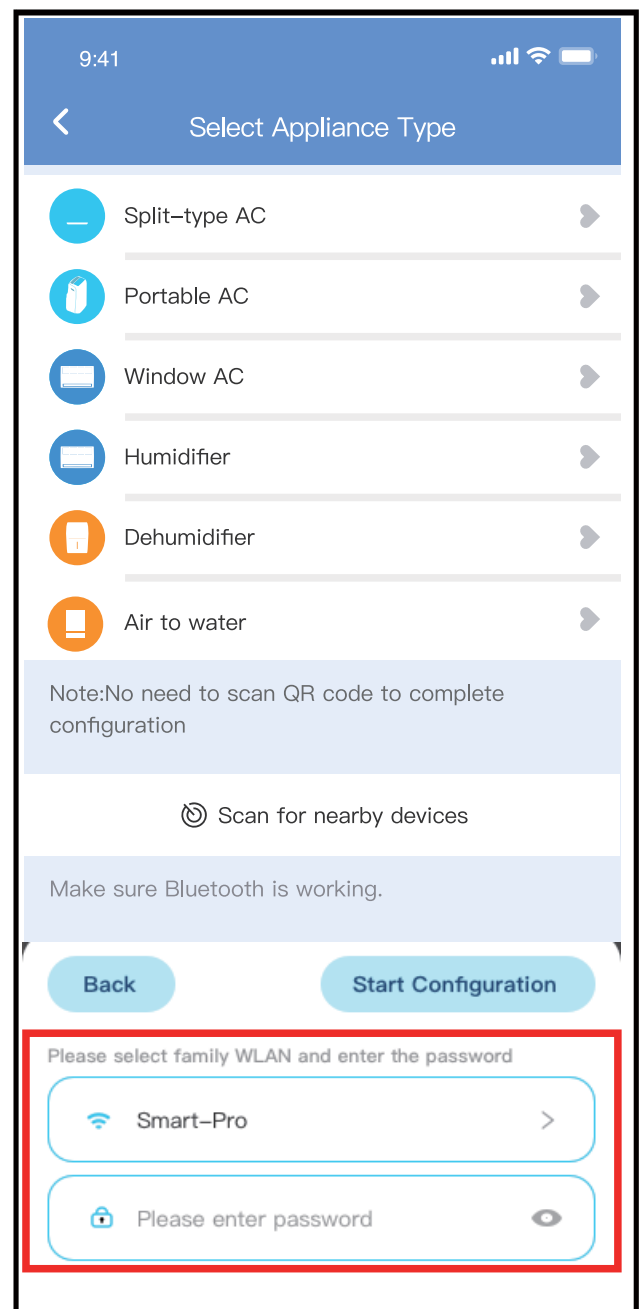

④ Select home Wi-Fi, enter the password

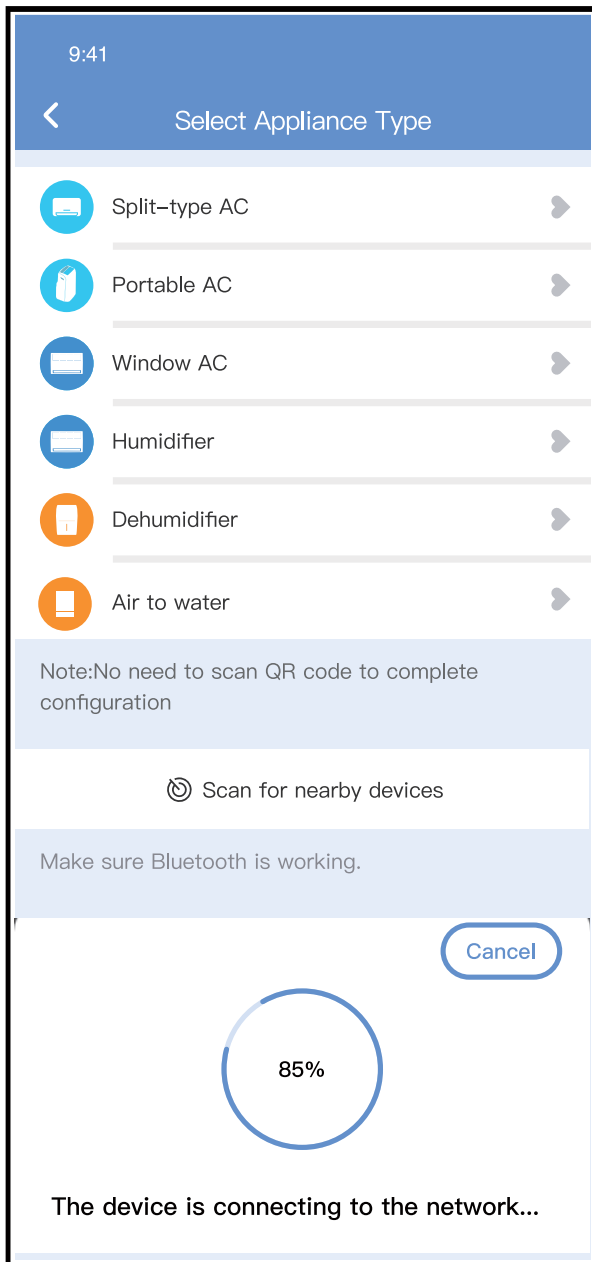

⑤ Wait connecting to the network

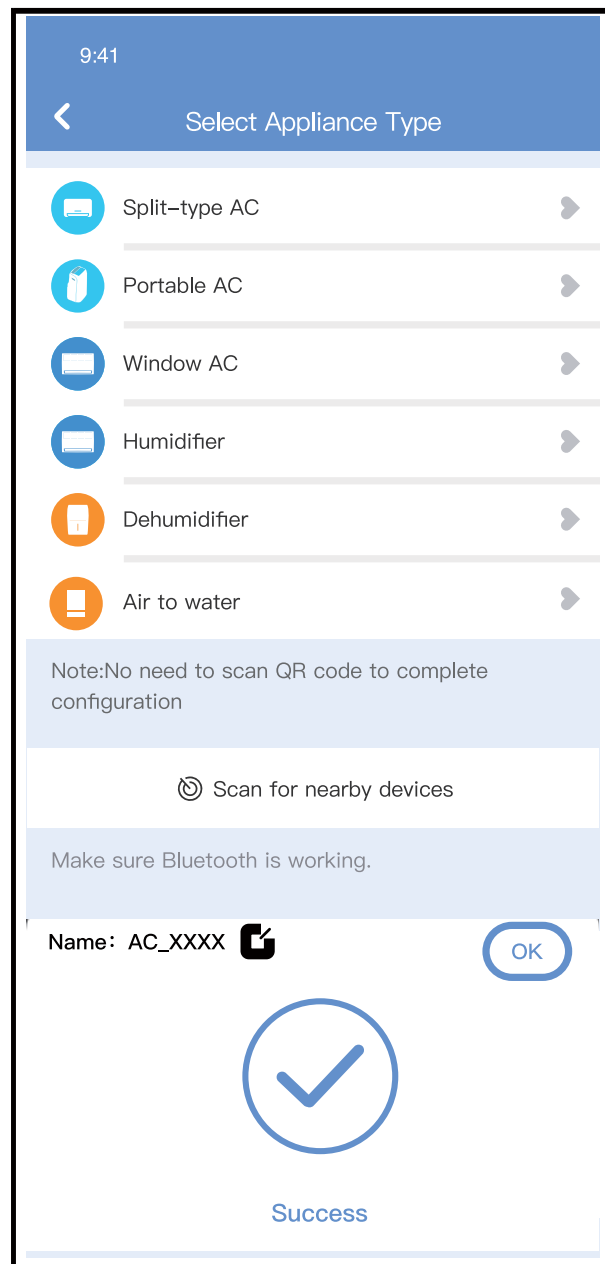

⑥ Configuration Success, you can modify the default name.

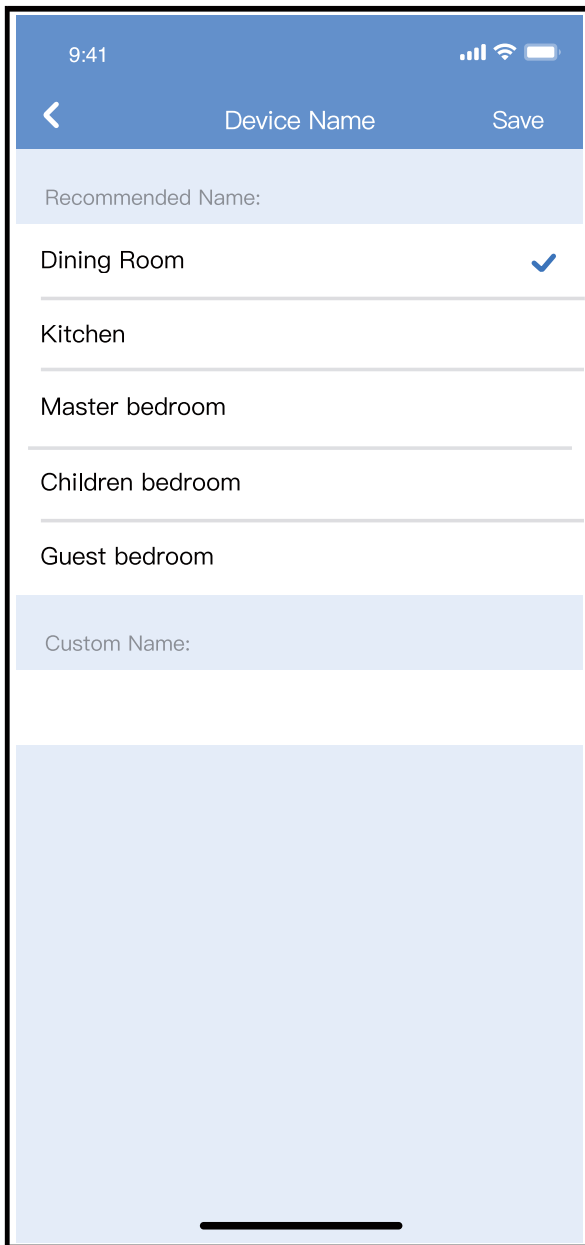

- ⑦ You can choose an existing name or customize a new name.

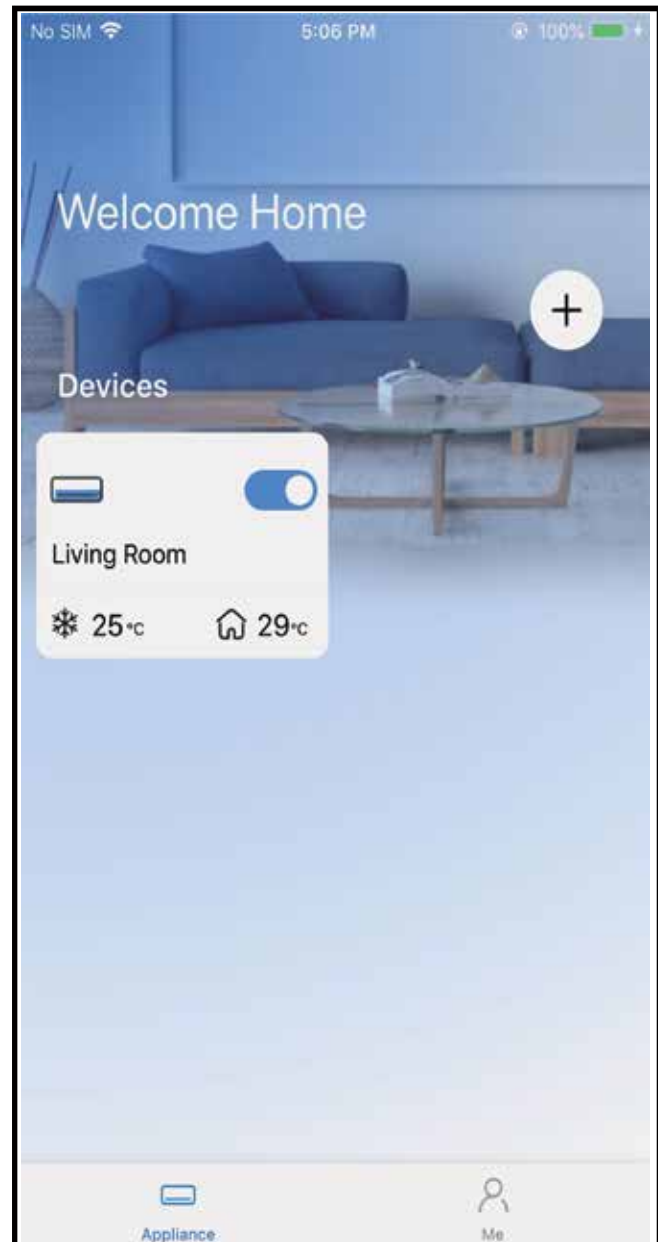

- ⑧ Bluetooth network configuration is successful, now you can see the device in the list.

Network configuration by select appliance type :

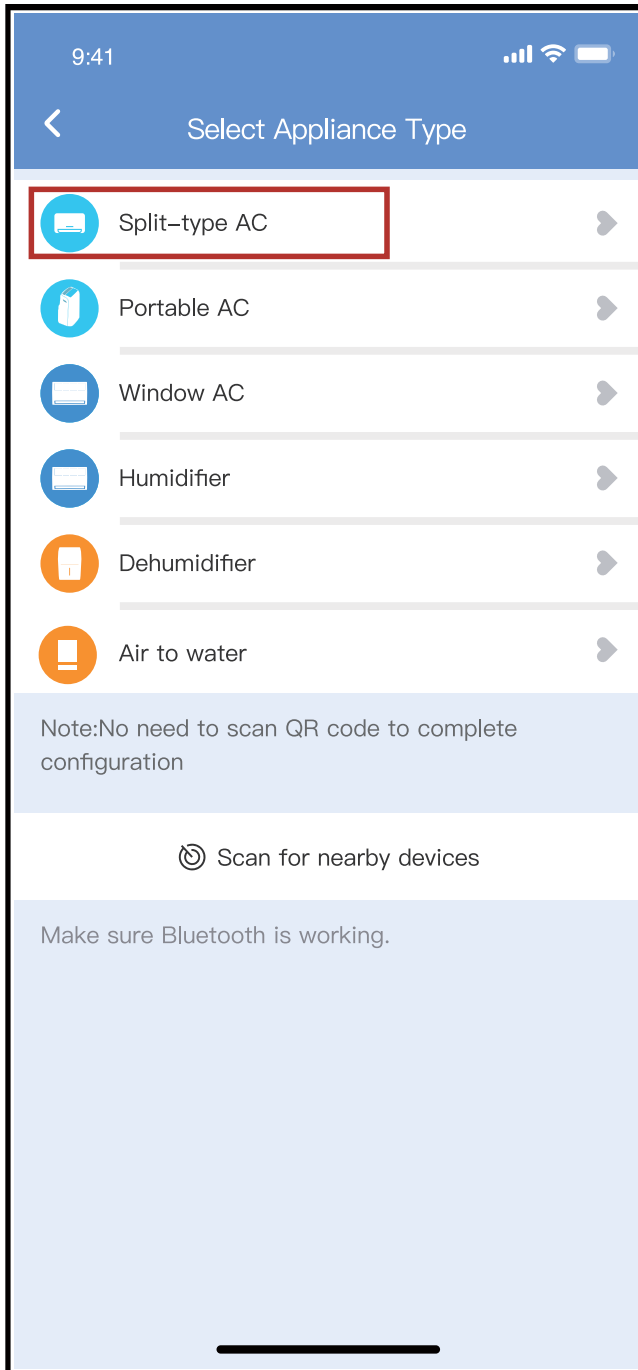

① If the bluetooth network configuration fails, please select the appliance type.

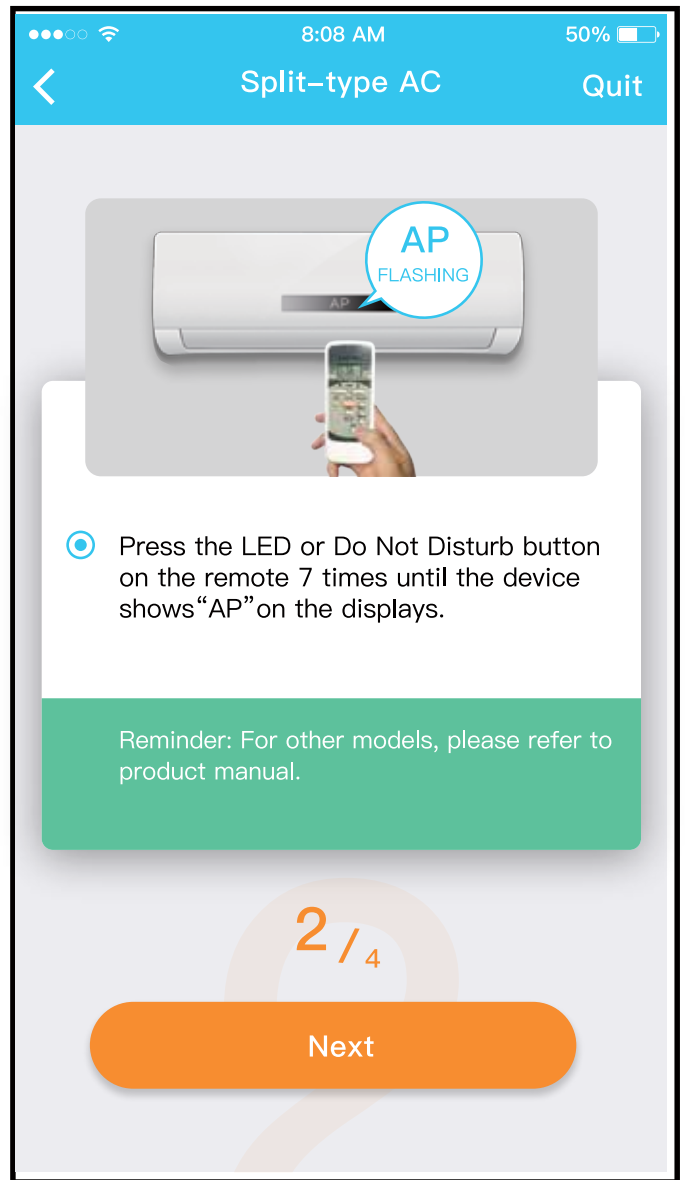
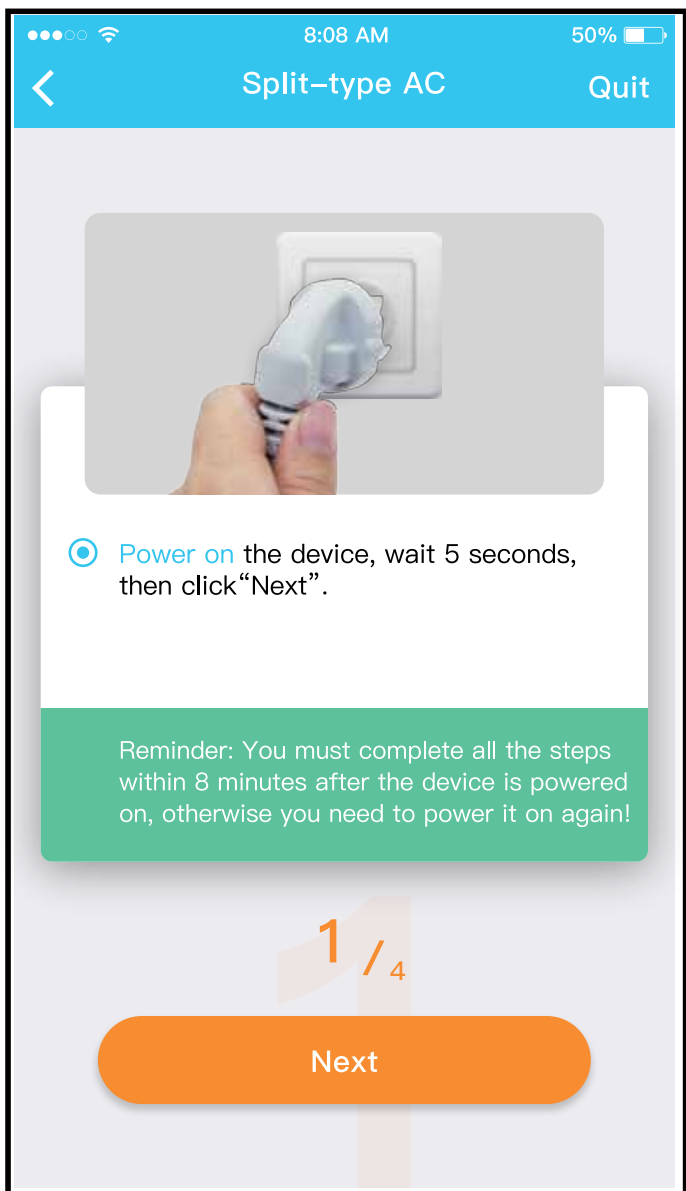

② please follow the above steps to enter "AP" mode.

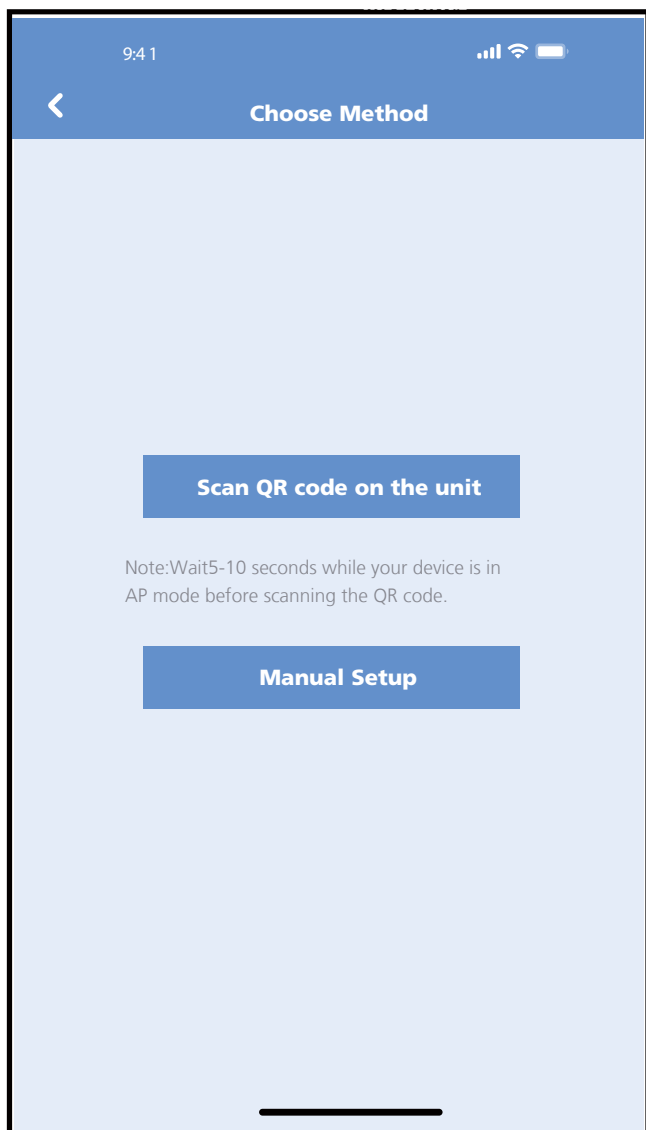

③ Choose the network configuration method.

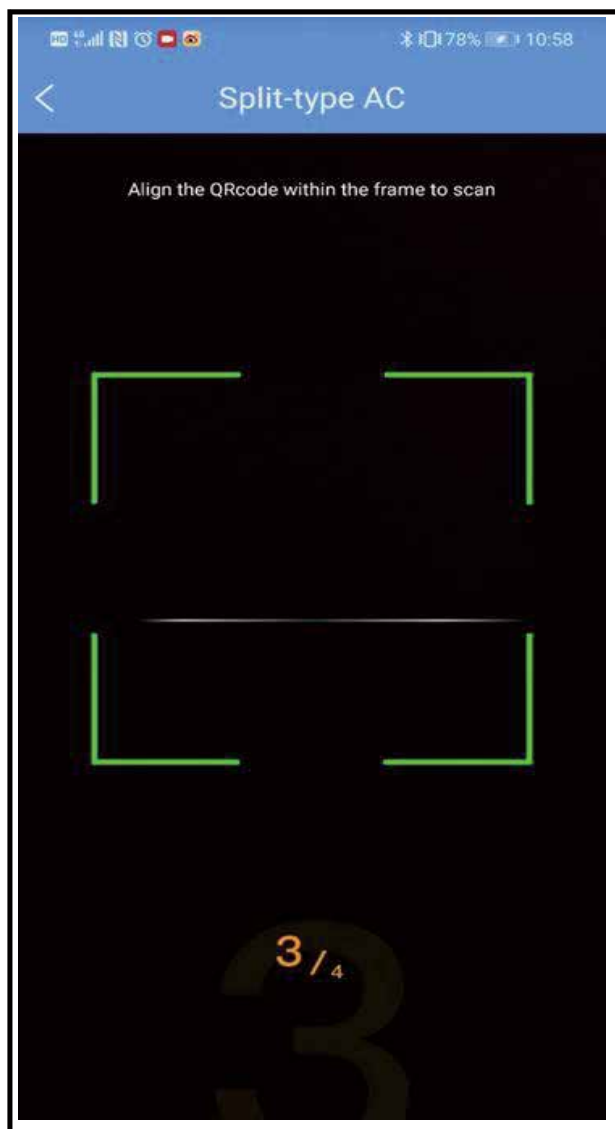

④ Choose the “Scan the QR code” method.

NOTE: Steps ③ and ④ are applicable to Android system only. iOS system does not need these two steps.

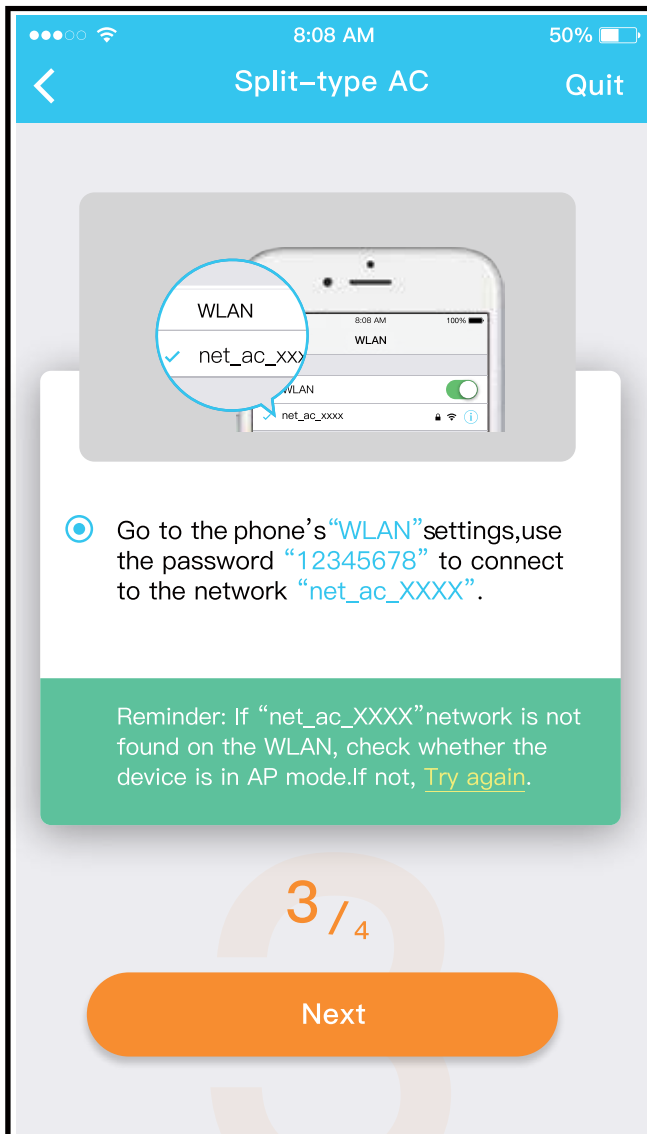

- ⑤ When choosing the "Manual Setup" method (Android). Connect to the wireless network (iOS)

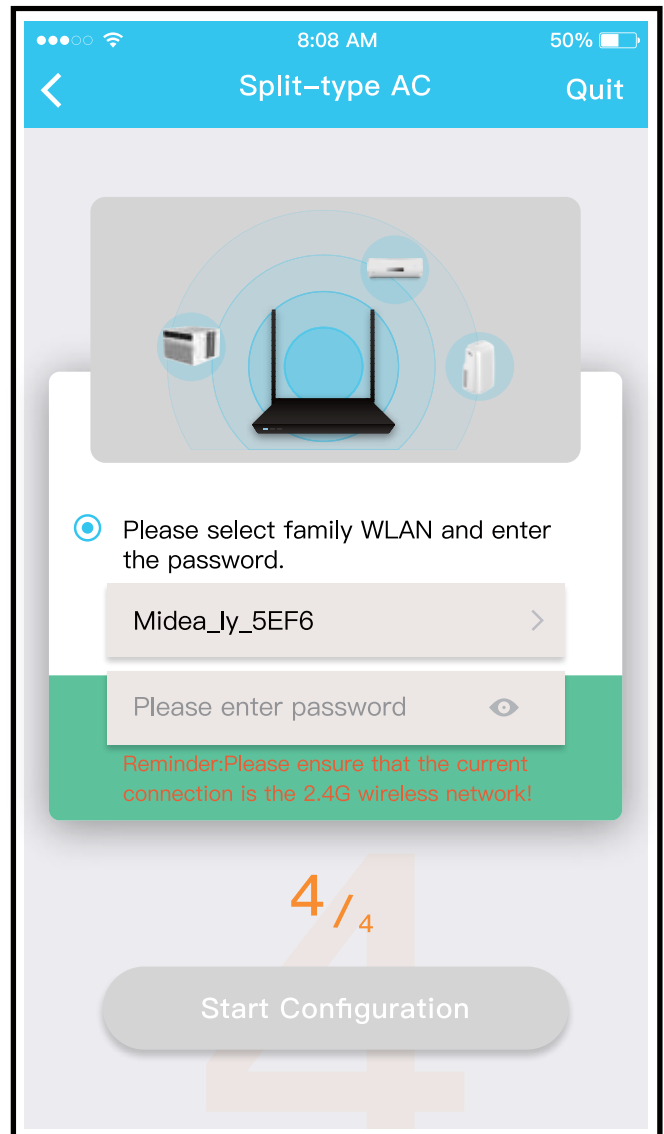

- ⑥ Please enter password

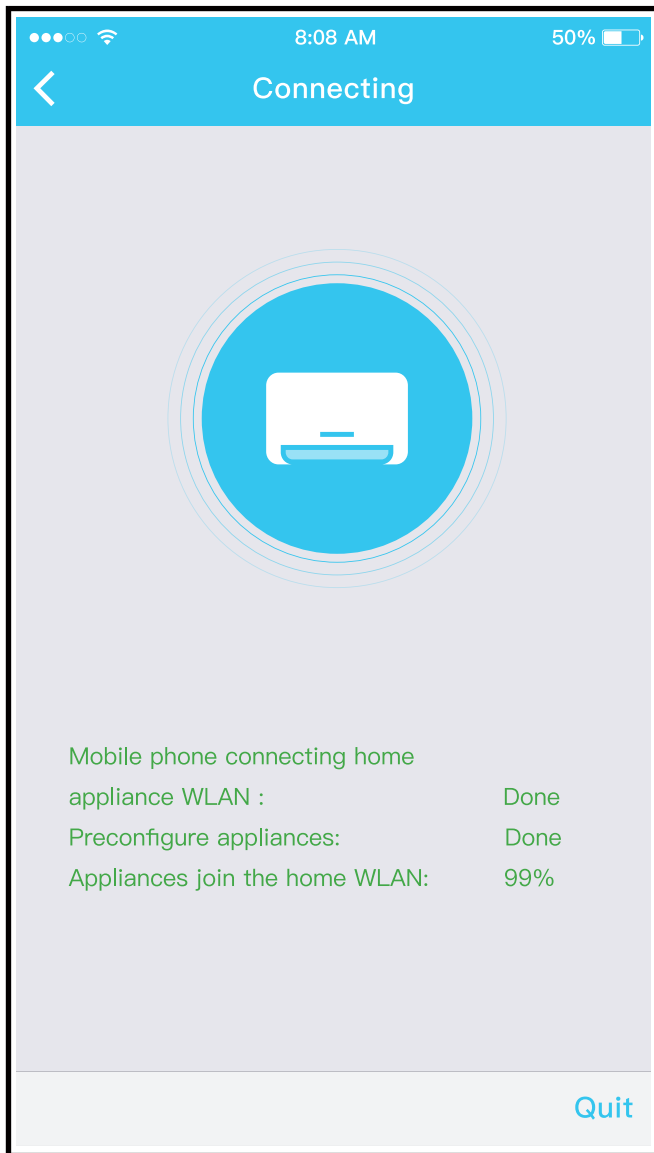

⑦ Network configuration is successful

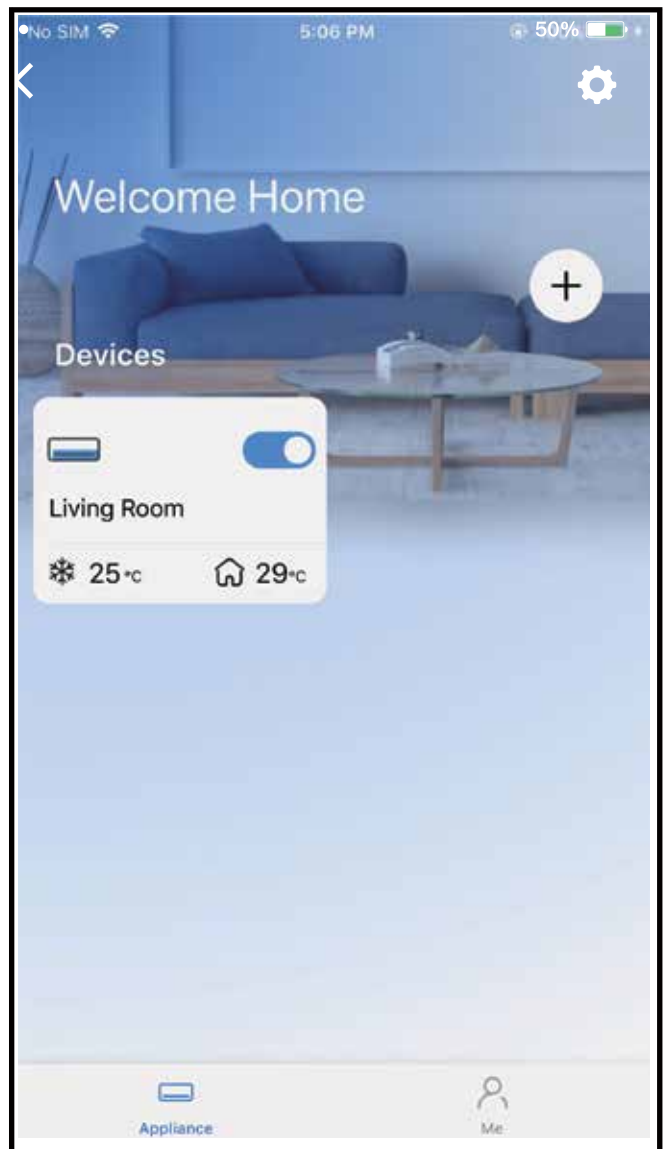

⑧ Configuration Success, you can see the device in the list.

NOTE:

- When finishing network configuration, APP will display success cue words on the screen.
- Due to different internet environments, it is possible that the device status still displays “offline” . If this situation occurs, it is necessary to pull and refresh the device list on the APP and make sure the device status becomes “online” . Alternatively, user can turn off the AC power and turn on it again, the device status will become “online” after a few minutes.

7 HOW TO USE APP

Please ensure both your mobile device and air conditioner are connected to the Internet before using app to control the air conditioner via internet, please follow the next steps:

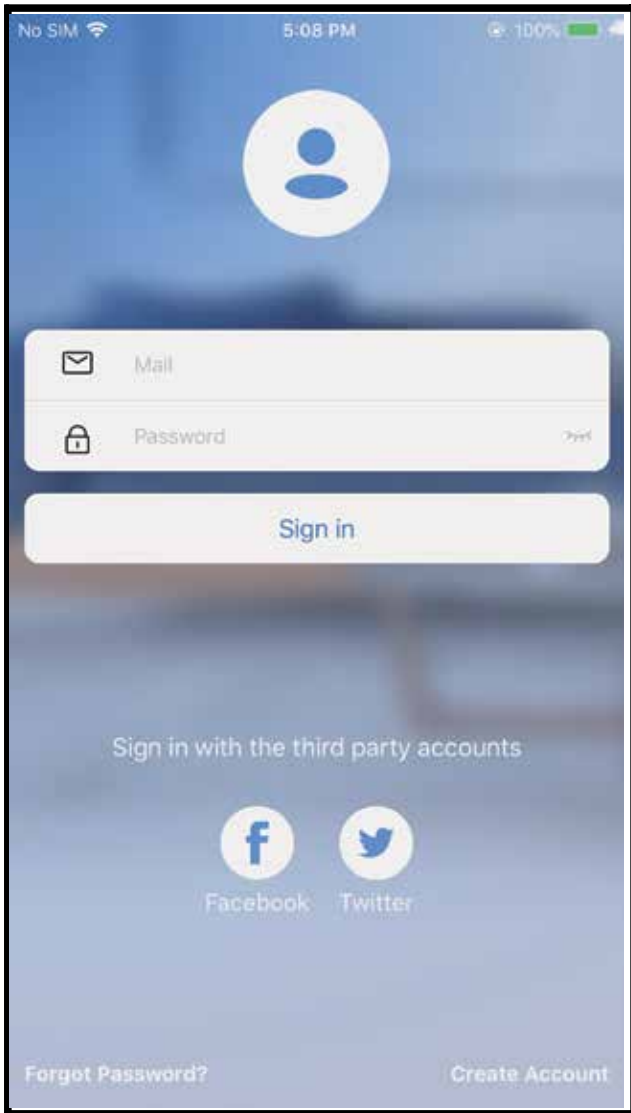

① Click " Sign in "

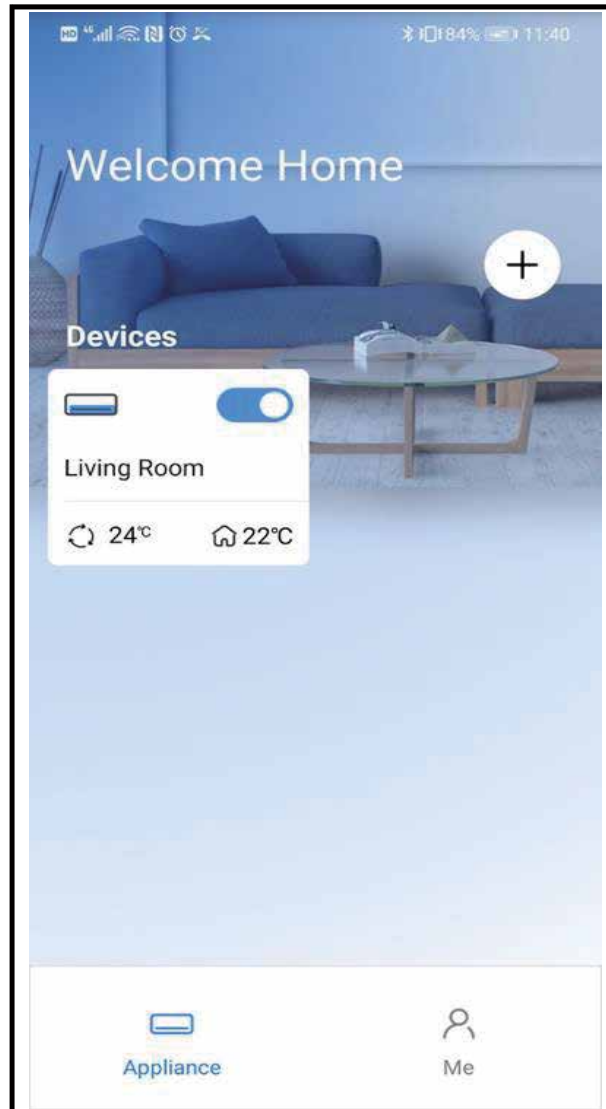

② Choose the air conditioner.



- ③ Thus, user can control air conditioners on/off status, operation mode, temperature, fan speed and so on.

NOTE:

Not all the function of the APP are available on air conditioner. For example: ECO, Turbo and Swing function please check the user manual to find more information.

8 SPECIAL FUNCTIONS

■ Schedule

Weekly, user can make an appointment to turn the A/C on or off for a specific time. User also can choose circulation to keep the AC under schedule control every week.

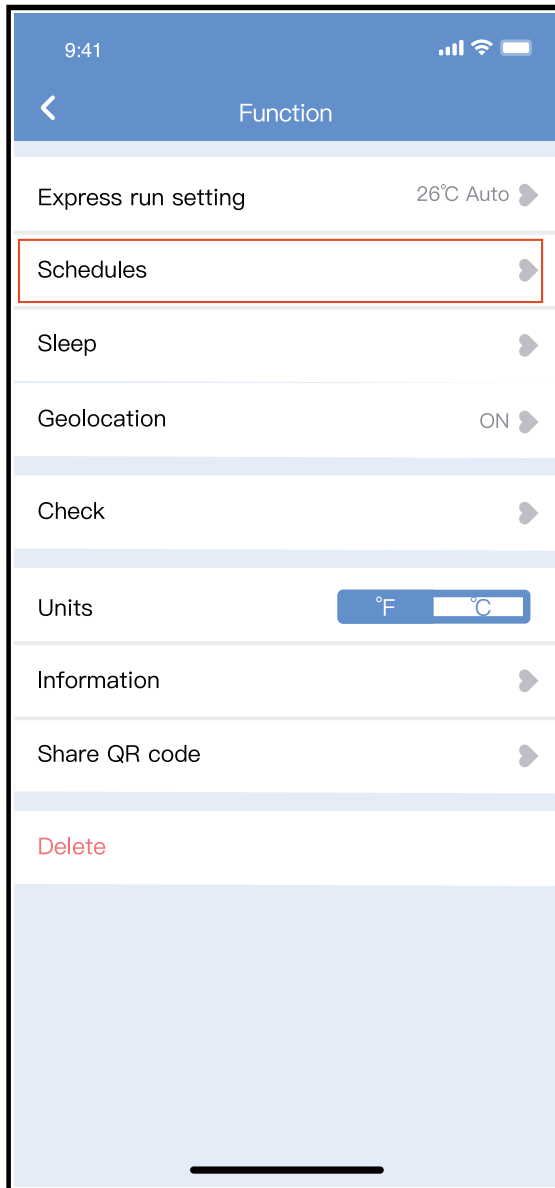

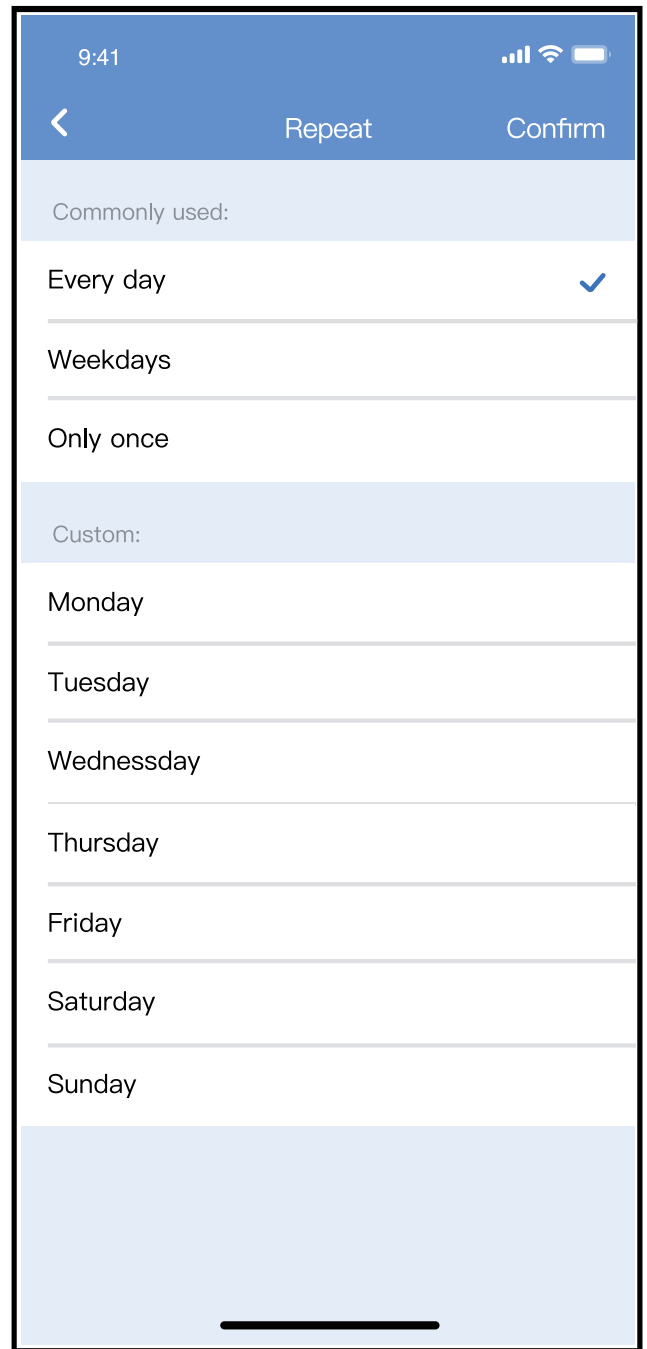
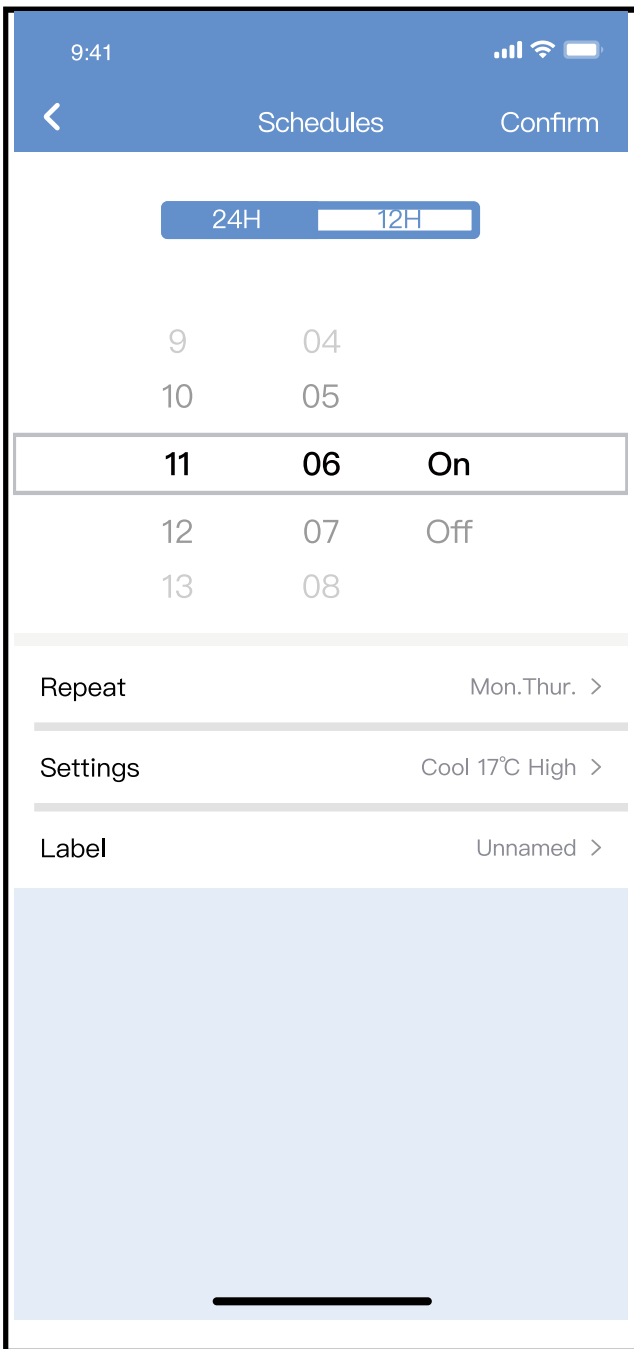

■ Sleep

User can customize their own comfortable sleep by setting target temperature.

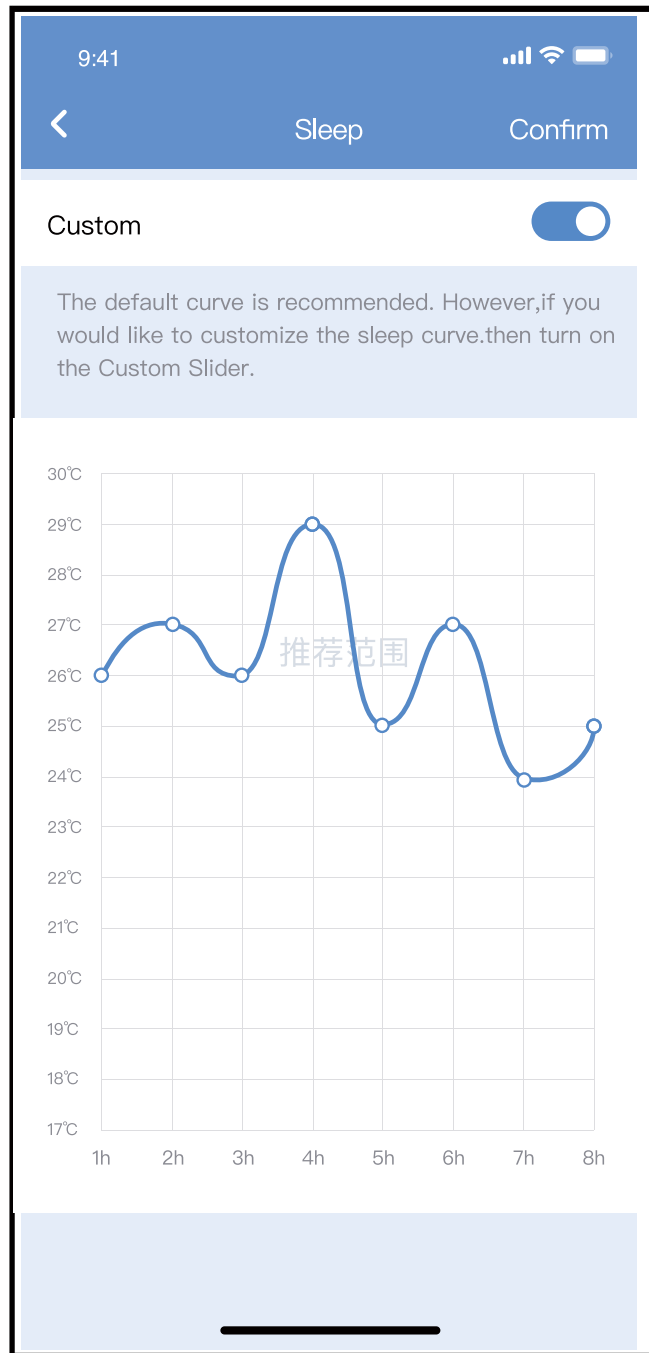
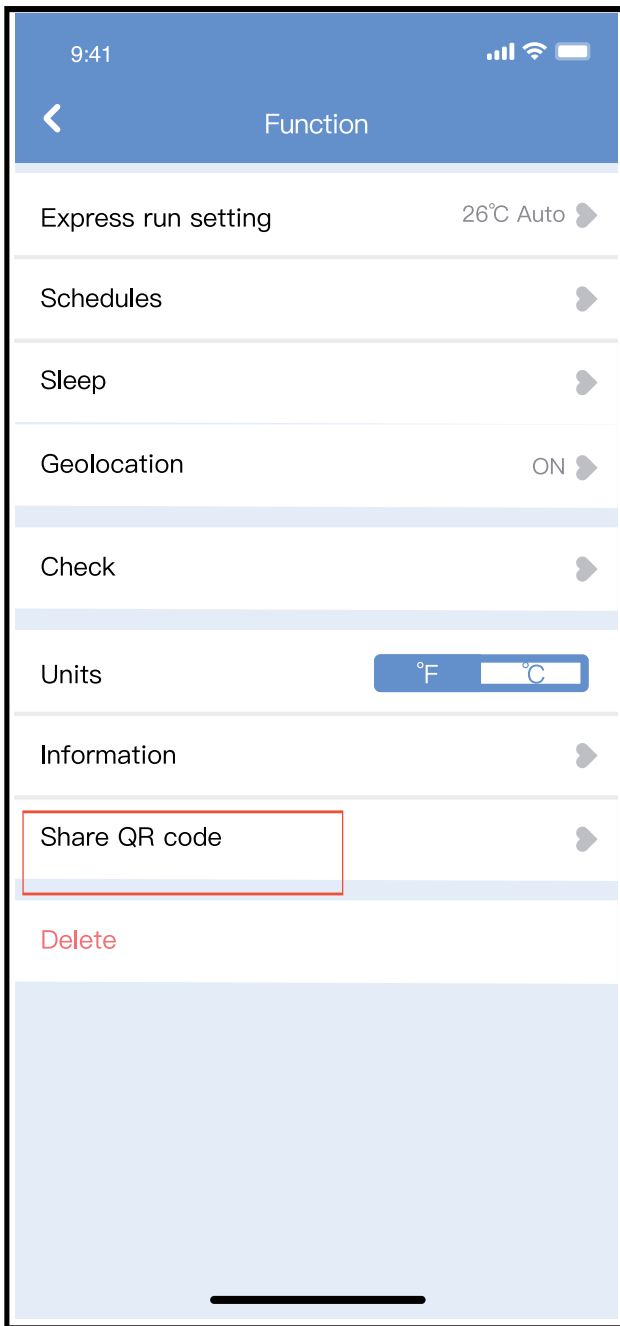

■ Check

User can simply check the AC running status with this function. When finishing this procedure, it can display the normal items, abnormal items, and detail information.

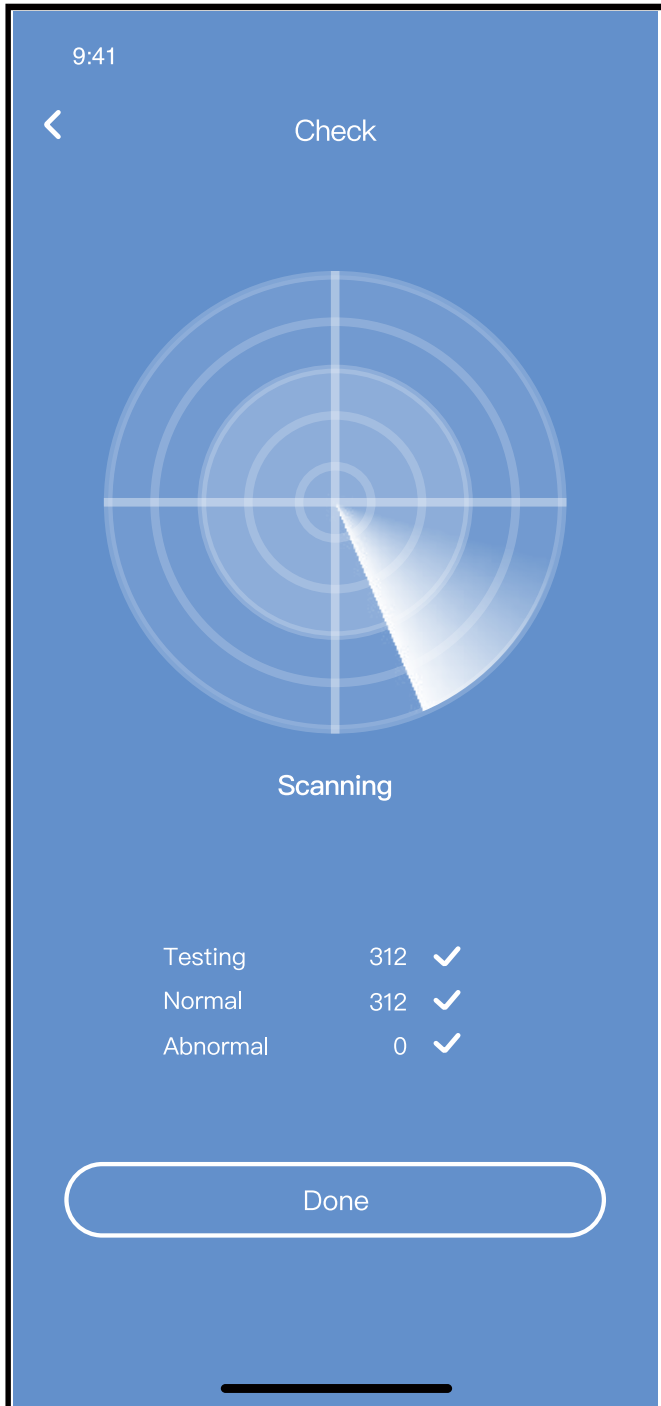

■ Share Device

The air conditioner can be controlled by multi-users at the same time by Share Device function.

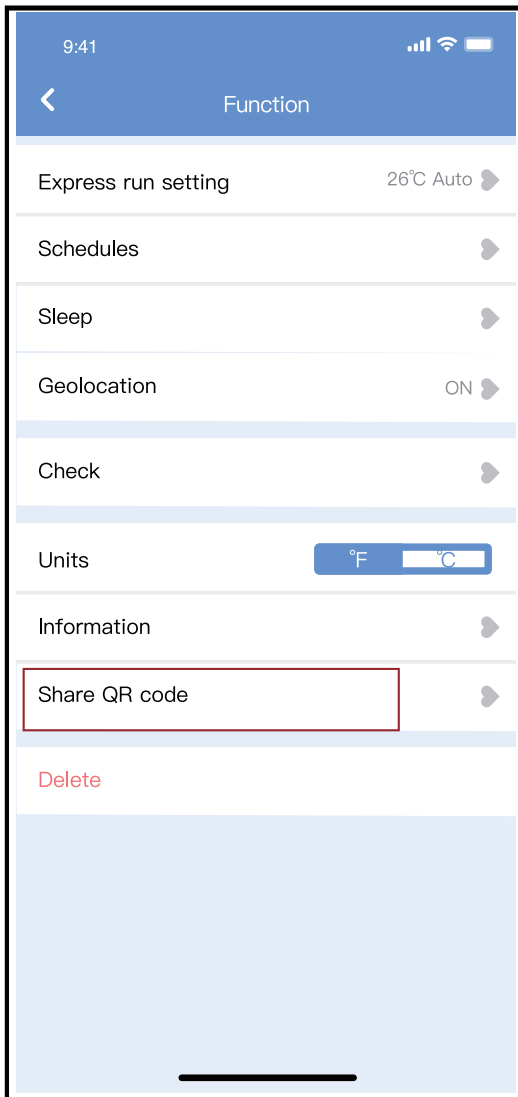

- ① Click “Shared QR code” ② QR code display.

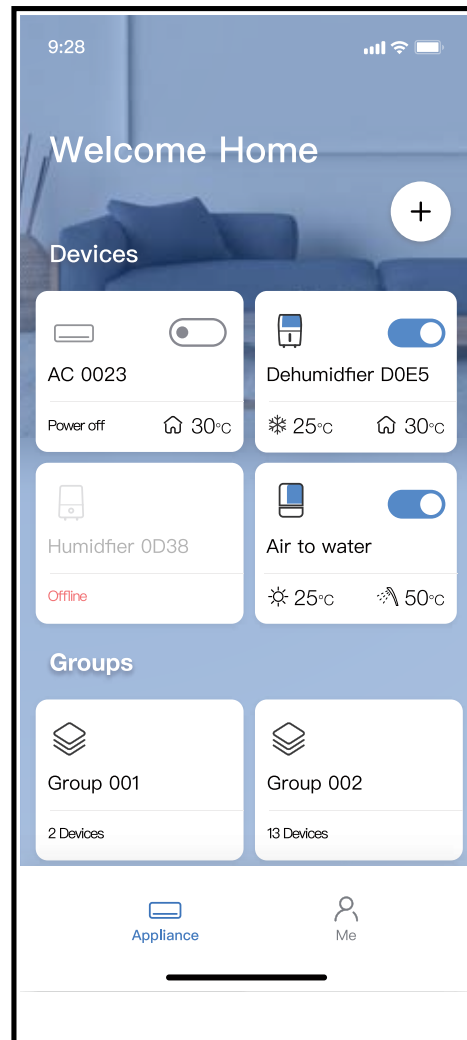
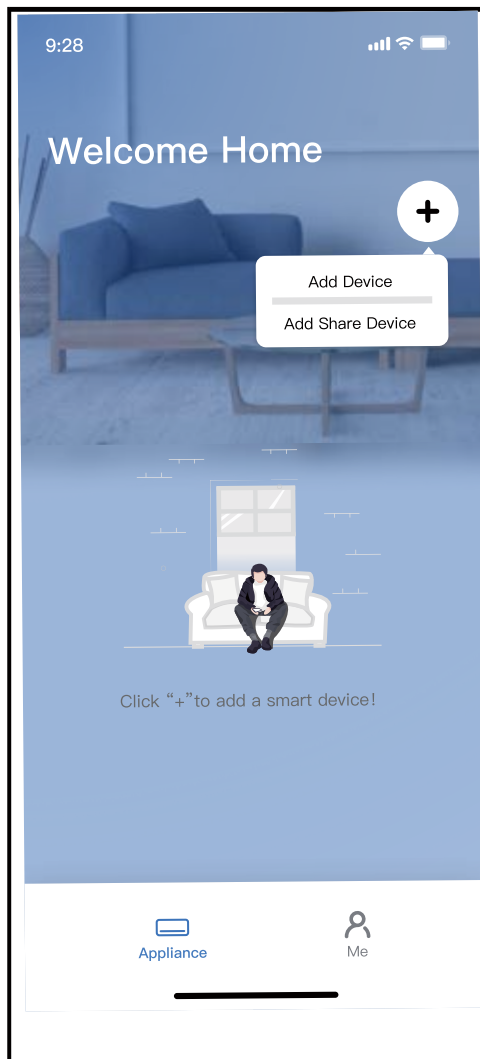

③ The other users must log in "Nethome Plus" app first, then click "Add Share Device" on their own mobile, then ask them to scan the QR code.

④ Now the others can add the shared device.

CAUTIONS:

For models of US-OSK105, EU-OSK105:

FCC ID:2AS2HMZNA21

IC:24951-MZNA21

This device complies with Part 15 of the FCC Rules and it contains licence-exempt transmitter(s)/receiver(s) that comply with Innovation, Science and Economic Development Canada's licence-exempt RSS(s).

Operation is subject to the following to conditions:

- (1) This device may not cause interference; and
- (2) This device must accept any interference, including interference that may cause undesired operation of the device.

Only operate the device in accordance with the instructions supplied.

Changes or modifications to this unit not expressly approved by the party responsible for compliance could void the user's authority to operate the equipment.

This device complies with FCC radiation exposure limits set forth for an uncontrolled environment. In order to avoid the possibility of exceeding the FCC radio frequency exposure limits, human proximity to the antenna shall not be less than 20cm (8 inches) during normal operation.

NOTE: This equipment has been tested and found to comply with the limits for a Class B digital device, pursuant to part 15 of the FCC Rules. These limits are designed to provide reasonable protection against harmful interference in a residential installation. This equipment generates, uses and can radiate radio frequency energy and, if not installed and used in accordance with the instructions, may cause harmful interference to radio communications. However, there is no guarantee that interference will not occur in a particular installation. If this equipment does cause harmful interference to radio or television reception, which can be determined by turning the equipment off and on, the user is encouraged to try to correct the interference by one or more of the following measures:

- Reorient or relocate the receiving antenna.
- Increase the separation between the equipment and receiver.
- Connect the equipment into an outlet on a circuit different from that to which the receiver is connected.
- Consult the dealer or an experienced radio/TV technician for help.

Due to ongoing product improvements, specifications and dimensions are subject to change and correction without notice or incurring obligations. Determining the application and suitability for use of any product is the responsibility of the installer. Additionally, the installer is responsible for verifying dimensional data on the actual product prior to beginning any installation preparations.

Incentive and rebate programs have precise requirements as to product performance and certification. All products meet applicable regulations in effect on date of manufacture; however, certifications are not necessarily granted for the life of a product. Therefore, it is the responsibility of the applicant to determine whether a specific model qualifies for these incentive/rebate programs.

